

1. Product main performance/产品主要性能指标:

Operating Temperature/工作温度 : -55°C~150°C

Humidity(max)/最大潮湿 : <=95% [at 60 deg C / 140 F]

Shielding /屏蔽性能 : 75dB(10MHz) 40dB(1GHz)

Salt Spray Corrosion/盐雾 : 96hr

Mechanical data/机械特性:

Vibration/振动 : 15g[10Hz~2000Hz]

Shock Resistance/冲击 : 100g[6ms]

Endurance (Shell)/机械寿命 : 5000+

Cable/配接电缆: ϕ 3.1mm- ϕ 4.0mm

2. 电气性能

Insert Configuration/针芯配置: OBP.302 2Low Voltage

Pin Size/接触件直径: ϕ 0.9mm

Contact resistance接触电阻: \leq 9m Ω

Insulation resistance/绝缘电阻: 5000M Ω (测试电压500V(DC))

Withstand voltage/耐电压: 1300V(AC)

Rated working current额定工作电流: 10.0A

Other Specification/其它规格:

Contact PIN/接触体 : Gold plated Tin bronze/锡青铜镀金

Housing Material/外壳材质 : PEEK

Other Shell Material/其它壳体材质: 铜镀镍

Insulator material/绝缘体材料: PPS

IP Rating/防护等级 : IP50

*ALL MATERIALS ARE RoHS COMPLIANT/所有材料均符合RoHS要求.

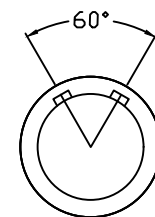
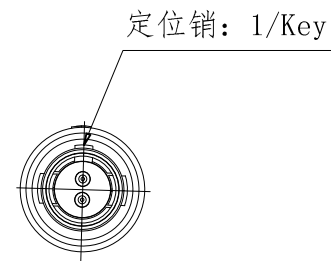
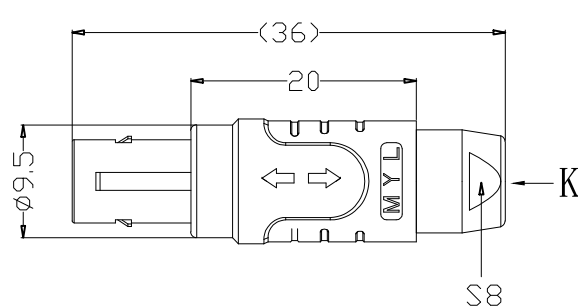

Plug front view
插头前视图

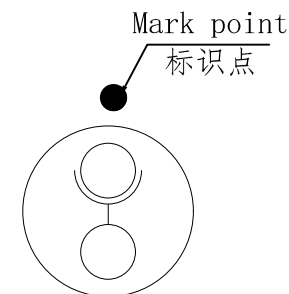

view K
K向孔位排列

DRAWN BY:
绘图: Z01 2024. 6. 12
CHECKED BY:
审核: Z01 2024. 6. 12
APPROVED BY:
核准: PD05 2024. 6. 12



美易连电子科技(深圳)有限公司
Meiyilian electronic technology(shenzhen)Co.Ltd.

GENERAL TOLERANCE
(UNLESS SPECIFIED)
 \leq 10 \pm 0.1
<10~ \leq 20 \pm 0.15
<20~ \leq 50 \pm 0.3
Angle \pm 1°

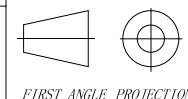

REV/版本 A1

单位
UNT: mm
比例
SCALE: 1: 1
SIZE: A4
SHEET: 1 OF 1

名称
PART NAME
型号
PART NAME

TG-OBP直式插头
(不带护套式尾冒)
TGB. OBP. 302. KWLAD42