

1. Product main performance/产品主要性能指标:

Operating Temperature/工作温度 : -55°C~150°C
 Humidity(max)/最大潮湿 : <=95% [at 60 deg C / 140 F]
 Shielding /屏蔽性能 : 75dB(10MHz) 40dB(1GHz)
 Salt Spray Corrosion/盐雾 : 96hr

Mechanical data/机械特性:

Vibration/振动 : 15g[10Hz~2000Hz]
 Shock Resistance/冲击 : 100g[6ms]
 Endurance (Shell)/机械寿命 : 5000+
 Cable/配接电缆: $\phi 2.4\text{mm}-\phi 3.3\text{mm}$

2. 电气性能

Insert Configuration/针芯配置: 1BP.306 6Low Voltage
 Pin Size/接触件直径: $\phi 0.7\text{mm}$
 Contact resistance接触电阻: $\leq 12.5\text{m}\Omega$
 Insulation resistance/绝缘电阻: $5000\text{M}\Omega$ (测试电压500V(DC))
 Withstand voltage/耐电压: 1050V(AC)
 Rated working current额定工作电流: 7.0A

Other Specification/其它规格:

Contact PIN/接触体 : Gold plated Tin bronze/锡青铜镀金
 Housing Material/外壳材质 : PEEK
 Other Shell Material/其它壳体材质: 铜镀镍
 Insulator material/绝缘体材料: PPS
 IP Rating/防护等级 : IP50

*ALL MATERIALS ARE RoHS COMPLIANT/所有材料均符合RoHS要求.

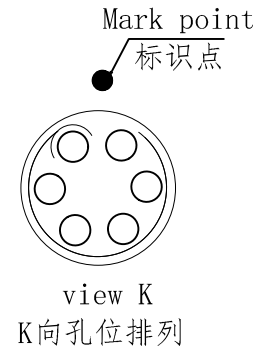
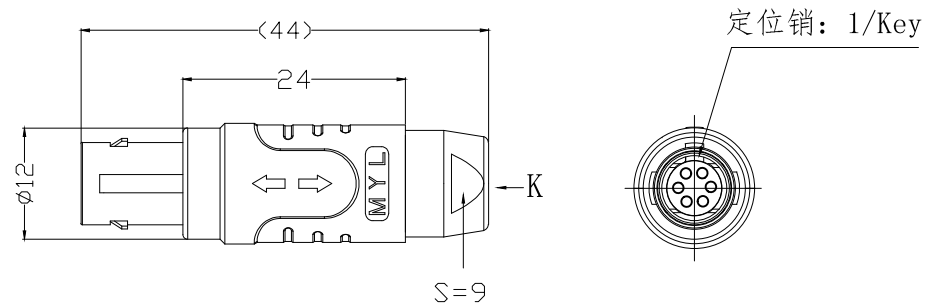

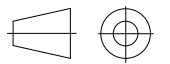
DRAWN BY: 绘图: Z01 2024. 6. 17 CHECKED BY: 审核: Z01 2024. 6. 17 APPROVED BY: 核准: PD05 2024. 6. 17		 美易连 美易连电子科技(深圳)有限公司 Meiyilian electronic technology(shenzhen)Co. Ltd.	
GENERAL TOLERANCE (UNLESS SPECIFIED) $\leq 10 \pm 0.1$ $< 10 \sim \leq 20 \pm 0.15$ $< 20 \sim \leq 50 \pm 0.3$ Angle $\pm 1^\circ$	 FIRST ANGLE PROJECTION	单位 UNIT: mm	名称 PART NAME
		比例 SCALE: 1: 1	TGG-1BP直式插头 (不带护套式尾冒)
REV/版本	A1	型号 PART NAME	TGG. 1BP. 306. KWLAD35
		SHEET: 1 OF 1	