

1. Product main performance/产品主要性能指标:

Operating Temperature/工作温度 : -55°C~150°C
 Humidity(max)/最大潮湿 : <=95% [at 60 deg C / 140 F]
 Shielding /屏蔽性能 : 75dB(10MHz) 40dB(1GHz)
 Salt Spray Corrosion/盐雾 : 96hr

Mechanical data/机械特性:

Vibration/振动 : 15g[10Hz~2000Hz]
 Shock Resistance/冲击 : 100g[6ms]
 Endurance (Shell)/机械寿命 : 5000+
 Cable/配接电缆: ϕ 3.1mm- ϕ 4.0mm

2. 电气性能

Insert Configuration/针芯配置: OBP.306 6Low Voltage
 Pin Size/接触件直径: ϕ 0.5mm
 Contact resistance接触电阻: \leq 15m Ω
 Insulation resistance/绝缘电阻: 5000M Ω (测试电压500V(DC))
 Withstand voltage/耐电压: 850V(AC)
 Rated working current额定工作电流: 2.5A

Other Specification/其它规格:

Contact PIN/接触体 : Gold plated Tin bronze/锡青铜镀金
 Housing Material/外壳材质 : PEEK
 Other Shell Material/其它壳体材质: 铜镀镍
 Insulator material/绝缘体材料: PPS
 IP Rating/防护等级 : IP50

*ALL MATERIALS ARE RoHS COMPLIANT/所有材料均符合RoHS要求.

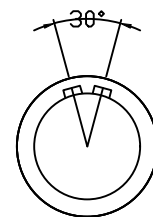
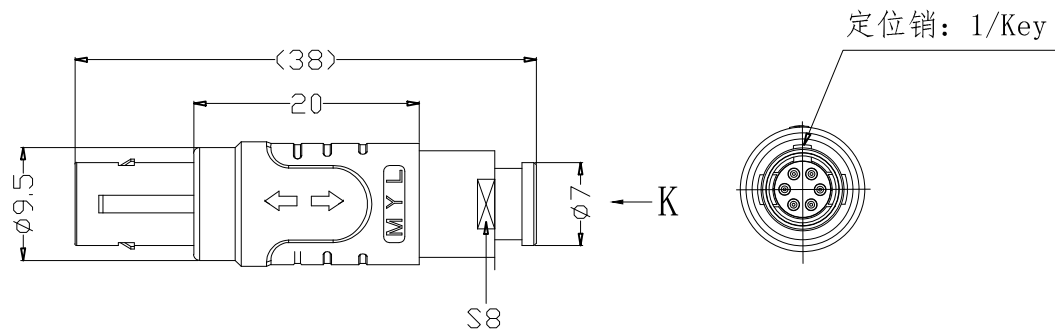

Plug front view
插头前视图

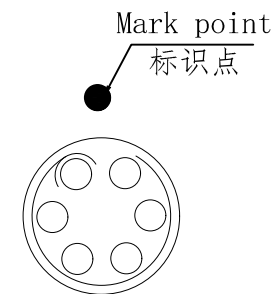

view K
K向孔位排列

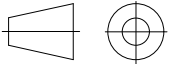
DRAWN BY: 绘图: Z01 2024. 6. 7 CHECKED BY: 审核: Z01 2024. 6. 7 APPROVED BY: 核准: PD05 2024. 6. 7		 美易连 美易连电子科技(深圳)有限公司 Meiyilian electronic technology(shenzhen)Co.Ltd.	
GENERAL TOLERANCE (UNLESS SPECIFIED) $\leq 10 \pm 0.1$ $< 10 \sim \leq 20 \pm 0.15$ $< 20 \sim \leq 50 \pm 0.3$ Angle $\pm 1^\circ$	 FIRST ANGLE PROJECTION	单位 UNT: mm	名称 PART NAME TG-OBP直式插头 (带护套式尾冒)
		比例 SCALE: 1: 1	型号 PART NAME TGA. OBP. 306. KWLAD42Z
REV/版本 A1	SHEET: 1 OF 1		