

1. Product main performance/产品主要性能指标:

Operating Temperature/工作温度 : -55°C~150°C  
 Humidity(max)/最大潮湿 : <=95% [at 60 deg C / 140 F]  
 Shielding /屏蔽性能 : 75dB(10MHz) 40dB(1GHz)  
 Salt Spray Corrosion/盐雾 : 96hr

Mechanical data/机械特性:

Vibration/振动 : 15g[10Hz~2000Hz]  
 Shock Resistance/冲击 : 100g[6ms]  
 Endurance (Shell)/机械寿命 : 5000+

2. 电气性能

Insert Configuration/针芯配置:0BP.306 6Low Voltage  
 Pin Size/接触件直径:φ0.5mm  
 Contact resistance接触电阻:≤15mΩ  
 Insulation resistance/绝缘电阻:5000MΩ (测试电压500V(DC))  
 Withstand voltage/耐电压:850V(AC)  
 Rated working current额定工作电流:2.5A

Other Specification/其它规格:

Contact PIN/接触体 : Gold plated Tin bronze/锡青铜镀金  
 Housing Material/外壳材质 : PEEK  
 Other Shell Material/其它壳体材质: 铜镀镍  
 Insulator material/绝缘体材料: PPS  
 IP Rating/防护等级 : IP50

\*ALL MATERIALS ARE RoHS COMPLIANT/所有材料均符合RoHS要求.

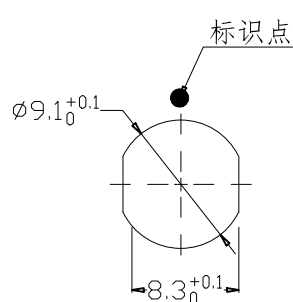
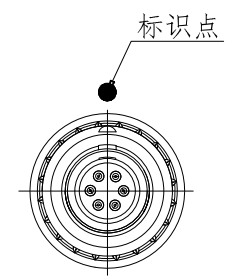
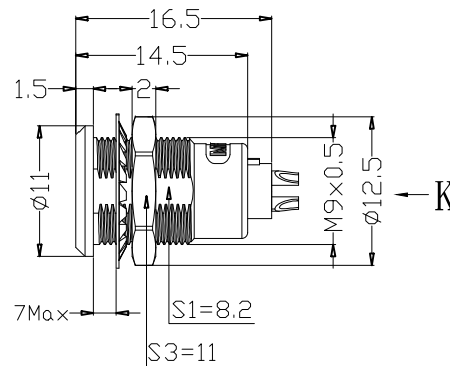

Panel cut-outs  
建议安装开孔尺寸

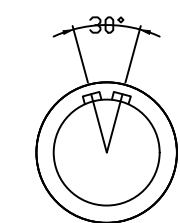

Socket front view  
插座前视图

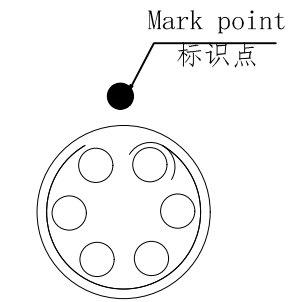

view K  
K向孔位排列

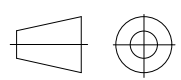
|   |  |   |                               |
|---|--|---|-------------------------------|
| DRAWN BY:<br>绘图:Z01 2024.6.14<br>CHECKED BY:<br>审核:Z01 2024.6.14<br>APPROVED BY:<br>核准:PD05 2024.6.14           |  |  美易连电子科技(深圳)有限公司<br>Meiyilian electronic technology(shenzhen)Co.Ltd. |                               |
| GENERAL TOLERANCE<br>(UNLESS SPECIFIED)<br>≤10 ±0.1<br><10~≤20 ±0.15<br><20~≤50 ±0.3<br>Angle ±1°               |  |   |                               |
| FIRST ANGLE PROJECTION<br> |  | 型号<br>PART NAME<br>ZGA.0BP.306.KWLL   | REV/版本<br>A1<br>SHEET: 1 OF 1 |