

1. Product main performance/产品主要性能指标:

Operating Temperature/工作温度 : -55℃~150℃
 Humidity(max)/最大潮湿 : <=95% [at 60 deg C / 140 F]
 Shielding /屏蔽性能 : 75dB(10MHz) 40dB(1GHz)
 Salt Spray Corrosion/盐雾 : 96hr

Mechanical data/机械特性:

Vibration/振动 : 15g[10Hz~2000Hz]
 Shock Resistance/冲击 : 100g[6ms]
 Endurance (Shell)/机械寿命 : 5000+

2. 电气性能

Insert Configuration/针芯配置:0BP.310 10Low Voltage
 Pin Size/接触件直径:Φ0.5mm
 Contact resistance接触电阻:≤15mΩ
 Insulation resistance/绝缘电阻:5000MΩ (测试电压500V(DC))
 Withstand voltage/耐电压:600V(AC)
 Rated working current额定工作电流:2.0A

Other Specification/其它规格:

Contact PIN/接触体 : Gold plated Tin bronze/锡青铜镀金
 Housing Material/外壳材质 : PEEK
 Other Shell Material/其它壳体材质: 铜镀镍
 Insulator material/绝缘体材料: PPS
 IP Rating/防护等级 : IP50

*ALL MATERIALS ARE RoHS COMPLIANT/所有材料均符合RoHS要求.

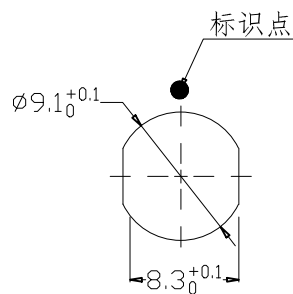
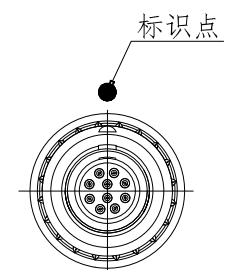
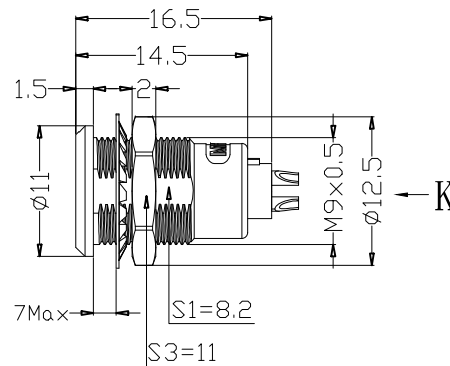

Panel cut-outs
建议安装开孔尺寸

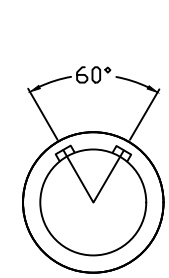

Socket front view
插座前视图

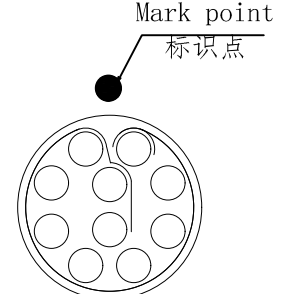

view K
K向孔位排列

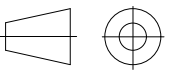
| | | | |
|---|---|--|-------------------------------------|
| DRAWN BY: 绘图:Z01 2024.6.14 CHECKED BY: 审核:Z01 2024.6.14 APPROVED BY: 核准:PD05 2024.6.14 | |  美易连 美易连电子科技(深圳)有限公司 Meiyilian electronic technology(shenzhen)Co.Ltd. | |
| GENERAL TOLERANCE (UNLESS SPECIFIED) ≤10 ±0.1 <10~≤20 ±0.15 <20~≤50 ±0.3 Angle ±1° |  FIRST ANGLE PROJECTION | 单位 UNIT: mm | 名称 PART NAME ZG-0BP固定式插座 |
| | | 比例 SCALE: 1: 1 | 型号 PART NAME ZGB.0BP.310.KWLL |
| REV/版本 A1 | SHEET: 1 OF 1 | | |