

1) Product main performance/产品主要性能指标:

Operating Temperature/工作温度 : -55°C~150°C
 Humidity(max)/最大潮湿 : <=95% [at 60 deg C / 140 F]
 Shielding /屏蔽性能 : 75dB(10MHz) 40dB(1GHz)
 Salt Spray Corrosion/盐雾 : 96hr

Mechanical data/机械特性:

Vibration/振动 : 15g[10Hz~2000Hz]
 Shock Resistance/冲击 : 100g[6ms]
 Endurance (Shell)/机械寿命 : 5000+

2. 电气性能

Insert Configuration/针芯配置:0BP.304 4Low Voltage
 Pin Size/接触件直径:φ0.7mm
 Contact resistance接触电阻:≤12.5mΩ
 Insulation resistance/绝缘电阻:5000MΩ (测试电压500V(DC))
 Withstand voltage/耐电压:850V(AC)
 Rated working current额定工作电流:7.0A

Other Specification/其它规格:

Contact PIN/接触体 : Gold plated Tin bronze/锡青铜镀金
 Housing Material/外壳材质 : PEEK
 Other Shell Material/其它壳体材质: 铜镀镍
 Insulator material/绝缘体材料: PEEK
 IP Rating/防护等级 : IP50

*ALL MATERIALS ARE RoHS COMPLIANT/所有材料均符合RoHS要求.

REV/版本	DESCRIPTION/变更内容	DATE/日期	DRAWN BY/绘图

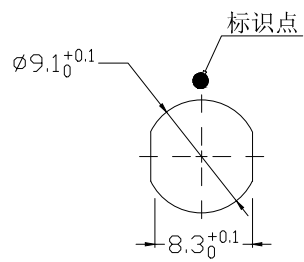
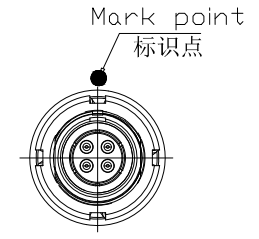
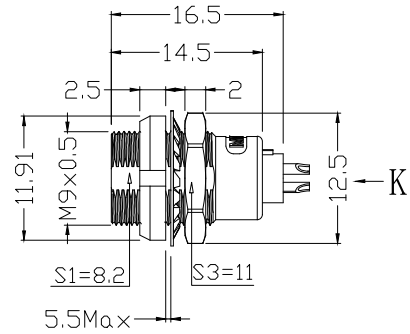

Panel cut-outs
建议安装开孔尺寸

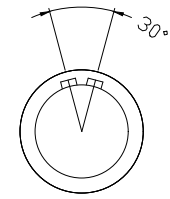

Socket front view
插座前视图

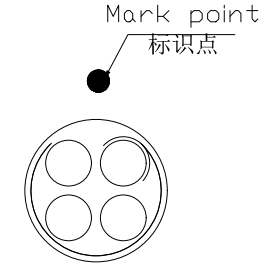

view K
K向孔位排列

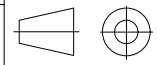
DRAWN BY: 绘图: PD03 2024.05.28 CHECKED BY: 审核: Z01 2024.05.28 APPROVED BY: 核准: PD05 2024.05.28		 美易连电子科技(深圳)有限公司 Meiyilian electronic technology(shenzhen)Co.,Ltd.		
GENERAL TOLERANCE (UNLESS SPECIFIED) ≤10 ±0.1 <10~≤20 ±0.15 <20~≤50 ±0.3 AngIe ±1°		 FIRST ANGLE PROJECTION	单位 UNIT: mm 比例 SCALE: 1: 1 型号 PART NAME	名称 PART NAME ZCA-OBP固定式插座 ZCA-OBP Fixed socket
REV/版本	A1	SHEET: 1 OF 1	型号 PART NAME ZCA. 0BP. 304. KWKL	