

1 2 3 4 5 6 7 8

REV/版本	DESCRIPTION/变更内容	DATE/日期	DRAWN BY/绘图

1. Product main performance/产品主要性能指标:

Operating Temperature/工作温度 : -55℃~150℃
 Humidity(max)/最大潮湿 : <=95% [at 60 deg C / 140 F]
 Salt Spray Corrosion/盐雾 : 96hr

Mechanical data/机械特性:

Vibration/振动 : 15g[10Hz~2000Hz]
 Endurance (Shell)/机械寿命 : 1200+

2. 电气性能

Insert Configuration/针芯配置:0P.304 4Low Voltage
 Pin Size/接触件直径:φ0.7mm
 Contact resistance接触电阻:≤12.5mΩ
 Insulation resistance/绝缘电阻:5000MΩ (测试电压500V(DC))
 Withstand voltage/耐电压:1500V(AC)
 Rated working current额定工作电流:7.0A
 Cable/配接电缆:φ4.0mm-φ4.6mm

Other Specification/其它规格:

Contact PIN/接触体 : Gold plated Tin bronze/锡青铜镀金
 Housing Material/外壳材质 : PSU
 Other Shell Material/其它壳体材质: PSU
 Insulator material/绝缘体材料: PEEK
 IP Rating/防护等级 : IP50
 *ALL MATERIALS ARE RoHS COMPLIANT/所有材料均符合RoHS要求.

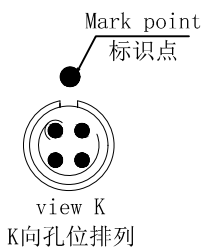
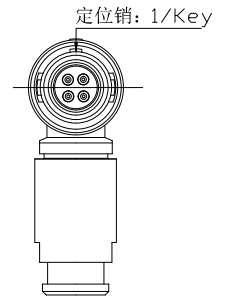
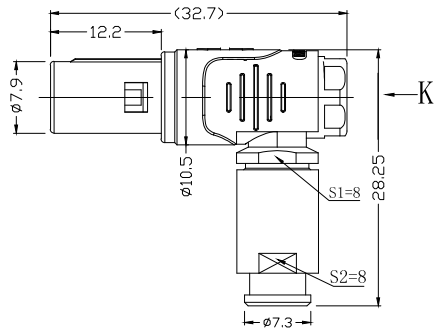

DRAWN BY:
绘图:PD03 2024.05.28
 CHECKED BY:
审核:Z01 2024.05.28
 APPROVED BY:
核准:PD05 2024.05.28



美易连电子科技(深圳)有限公司
 Meiyilian electronic technology(shenzhen)Co.,Ltd.

GENERAL TOLERANCE
(UNLESS SPECIFIED)
 ≤10 ±0.1
 <10~≤20 ±0.15
 <20~≤50 ±0.3
 Angle ±1°

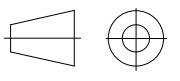
 FIRST ANGLE PROJECTION	单位 UNTT: mm 比例 SCALE: 1: 1	名称 PART NAME	PWG-0P 90° 弯角插头(带护套式尾帽) PWG-0P 90° Angle Plug (with jacketed tail cap)
	型号 PART NAME	PWG. 0P. 304. PKAC48GZ	
REV/版本 A1	SHEET: 1 OF 1	https://www.mylconnector.com/	

1 2 https://www.mylconnector.com/ 4 5 https://www.mylconnector.com/ 7 8