

1 2 3 4 5 6 7 8

REV/版本	DESCRIPTION/变更内容	DATE/日期	DRAWN BY/绘图

1. Product main performance/产品主要性能指标:  
 Operating Temperature/工作温度 : -55℃~150℃  
 Humidity(max)/最大潮湿 : <=95% [at 60 deg C / 140 F]  
 Salt Spray Corrosion/盐雾 : 96hr

Mechanical data/机械特性:  
 Vibration/振动 : 15g[10Hz~2000Hz]  
 Endurance (Shell)/机械寿命 : 1200+

2. 电气性能  
 Insert Configuration/针芯配置:0P.305 5Low Voltage  
 Pin Size/接触件直径:φ0.7mm  
 Contact resistance接触电阻:≤12.5mΩ  
 Insulation resistance/绝缘电阻:5000MΩ (测试电压500V(DC))  
 Withstand voltage/耐电压:1200V(AC)  
 Rated working current额定工作电流:6.5A  
 Cable/配接电缆:φ2.0mm-φ3.0mm

Other Specification/其它规格:  
 Contact PIN/接触体 : Gold plated Tin bronze/锡青铜镀金  
 Housing Material/外壳材质 : PSU  
 Other Shell Material/其它壳体材质: PSU  
 Insulator material/绝缘体材料: PEEK  
 IP Rating/防护等级 : IP50  
 \*ALL MATERIALS ARE RoHS COMPLIANT/所有材料均符合RoHS要求.

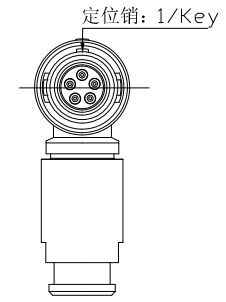
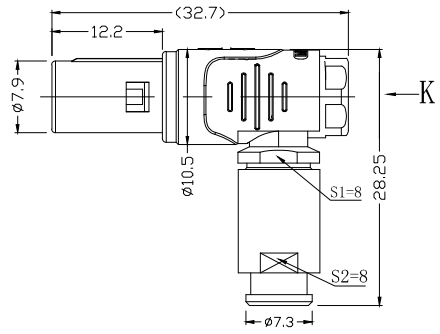

DRAWN BY:  
绘图:PD03 2024.05.28  
 CHECKED BY:  
审核:Z01 2024.05.28  
 APPROVED BY:  
核准:PD05 2024.05.28



美易连电子科技(深圳)有限公司  
 Meiyilian electronic technology(shenzhen)Co.,Ltd.

GENERAL TOLERANCE  
(UNLESS SPECIFIED)  
 ≤10 ±0.1  
 <10~≤20 ±0.15  
 <20~≤50 ±0.3  
 Angle ±1°

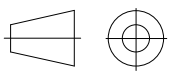
 FIRST ANGLE PROJECTION	单位 UNTT: mm 比例 SCALE: 1: 1	名称 PART NAME	PWG-0P 90° 弯角插头(带护套式尾帽) PWG-0P 90° Angle Plug (with jacketed tail cap)
	型号 PART NAME	PWG. 0P. 305. PKAC32GZ	
REV/版本 A1	SHEET: 1 OF 1	https://www.mylconnector.com/	

1 2 https://www.mylconnector.com/ 4 5 https://www.mylconnector.com/ 7 8