

REV/版本	DESCRIPTION/变更内容	DATE/日期	DRAWN BY/绘图

A

A

1. Product main performance/产品主要性能指标:

Operating Temperature/工作温度 : -55℃~150℃  
 Humidity(max)/最大潮湿 : <=95% [at 60 deg C / 140 F]  
 Salt Spray Corrosion/盐雾 : 96hr

Mechanical data/机械特性:

Vibration/振动 : 15g[10Hz~2000Hz]  
 Endurance (Shell)/机械寿命 : 1000+

2. 电气性能

Insert Configuration/针芯配置:3P.318 18Low Voltage  
 Pin Size/接触件直径:φ0.9mm  
 Contact resistance接触电阻:≤9mΩ  
 Insulation resistance/绝缘电阻:5000MΩ (测试电压500V(DC))  
 Withstand voltage/耐电压:850V(AC)  
 Rated working current额定工作电流:7.0A  
 Cable/配接电缆:φ7.6mm-φ8.5mm

Other Specification/其它规格:

Contact PIN/接触体 : Gold plated Tin bronze/锡青铜镀金  
 Housing Material/外壳材质 : PSU  
 Other Shell Material/其它壳体材质: PSU  
 Insulator material/绝缘体材料: PPS  
 IP Rating/防护等级 : IP61  
 \*ALL MATERIALS ARE RoHS COMPLIANT/所有材料均符合RoHS要求.

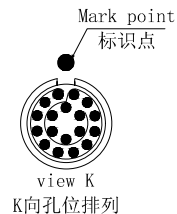
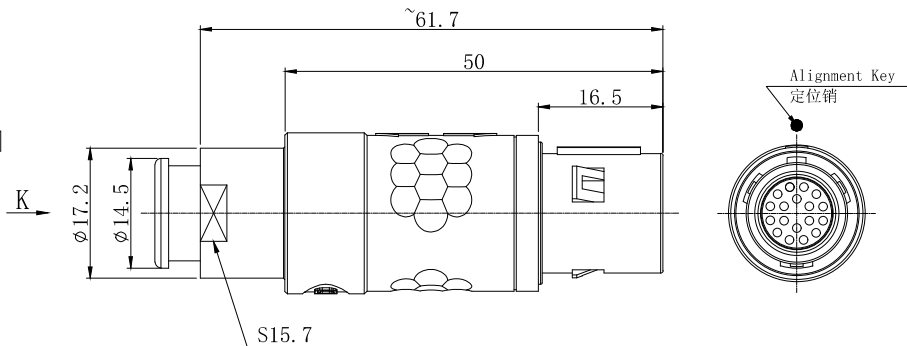

B

B

C

C

D

D

DRAWN BY: 绘图:PDO3 2024.05.28 CHECKED BY: 审核:Z01 2024.05.28 APPROVED BY: 核准:PDO5 2024.05.28		 美易连电子科技(深圳)有限公司 Meiyilian electronic technology(shenzhen)Co.,Ltd.	
GENERAL TOLERANCE (UNLESS SPECIFIED) ≤10 ±0.1 <10~≤20 ±0.15 <20~≤50 ±0.3 Angle ±1°			
FIRST ANGLE PROJECTION		REV/版本 A1 SHEET: 1 OF 1	型号 PART NAME PAG. 3P. 318. PLAC85GZ