

REV/版本	DESCRIPTION/变更内容	DATE/日期	DRAWN BY/绘图

1. Product main performance/产品主要性能指标:

Operating Temperature/工作温度 : -55℃~150℃
Humidity(max)/最大潮湿 : <=95% [at 60 deg C / 140 F]
Salt Spray Corrosion/盐雾 : 96hr

Mechanical data/机械特性:

Vibration/振动 : 15g[10Hz~2000Hz]
Endurance (Shell)/机械寿命 : 2000+

2. 电气性能

Insert Configuration/针芯配置:1P.309 9Low Voltage
Pin Size/接触件直径:φ0.5mm
Contact resistance接触电阻:≤15mΩ
Insulation resistance/绝缘电阻:5000MΩ (测试电压500V(DC))
Withstand voltage/耐电压:750V(AC)
Rated working current额定工作电流:2.5A
Cable/配接电缆:φ3.5mm-φ4.5mm

Other Specification/其它规格:

Contact PIN/接触体 : Gold plated Tin bronze/锡青铜镀金
Housing Material/外壳材质 : PSU
Other Shell Material/其它壳体材质: PSU
Insulator material/绝缘体材料: PPS
IP Rating/防护等级 : IP50

*ALL MATERIALS ARE RoHS COMPLIANT/所有材料均符合RoHS要求.

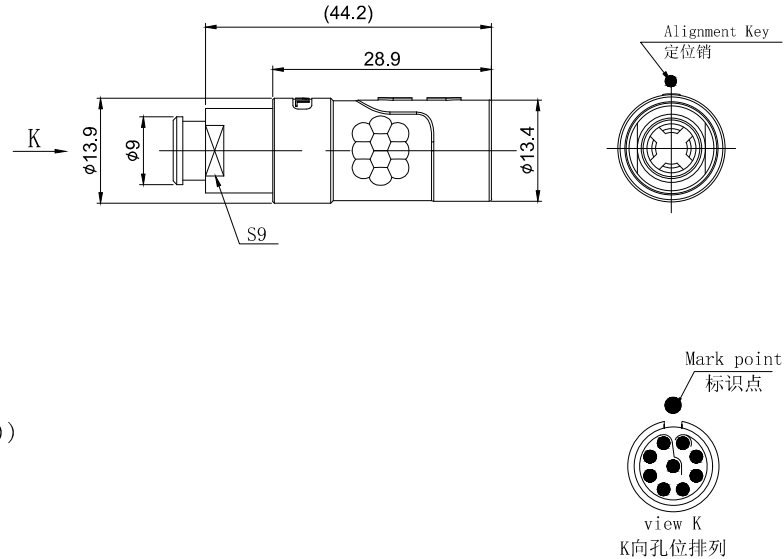

DRAWN BY:
绘图:PDO3 2024.05.28
CHECKED BY:
审核:Z01 2024.05.28
APPROVED BY:
核准:PDO5 2024.05.28



美易连电子科技(深圳)有限公司
Meiyilian electronic technology (shenzhen) Co., Ltd.

GENERAL TOLERANCE
(UNLESS SPECIFIED)
≤10 ±0.1
<10° ≤20 ±0.15
<20° ≤50 ±0.3
Angle ±1°

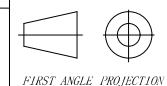

FIRST ANGLE PROJECTION

单位
UNIT: mm
比例
SCALE: 1:1
SIZE: A4
SHEET: 1 OF 1

名称
PART NAME
型号
PART NAME

PRG-1P浮动式插座(带护套式尾帽)
PRG-1P Floating socket
(with jacketed tail cap)
PRG. 1P. 309. PLLC42GZ