

REV./版本	DESCRIPTION/变更内容	DATE/日期	DRAWN BY/绘图

1. Product main performance/产品主要性能指标:

Operating Temperature/工作温度 : -55°C~150°C
 Humidity(max)/最大潮湿 : <=95% [at 60 deg C / 140 F]
 Salt Spray Corrosion/盐雾 : 96hr

Mechanical data/机械特性:

Vibration/振动 : 15g [10Hz~2000Hz]
 Endurance (Shell)/机械寿命 : 1000+

2. 电气性能

Insert Configuration/针芯配置:3P.303 3Low Voltage
 Pin Size/接触件直径:φ2.0mm
 Contact resistance接触电阻:≤3.5mΩ
 Insulation resistance/绝缘电阻:5000MΩ (测试电压500V(DC))
 Withstand voltage/耐电压:1500V(AC)
 Rated working current额定工作电流:25.0A
 Cable/配接电缆:φ7.6mm-φ8.5mm

Other Specification/其它规格:

Contact PIN/接触体 : Gold plated Tin bronze/锡青铜镀金
 Housing Material/外壳材质 : PSU
 Other Shell Material/其它壳体材质: PSU
 Insulator material/绝缘体材料: PPS
 IP Rating/防护等级 : IP61

*ALL MATERIALS ARE RoHS COMPLIANT/所有材料均符合RoHS要求.

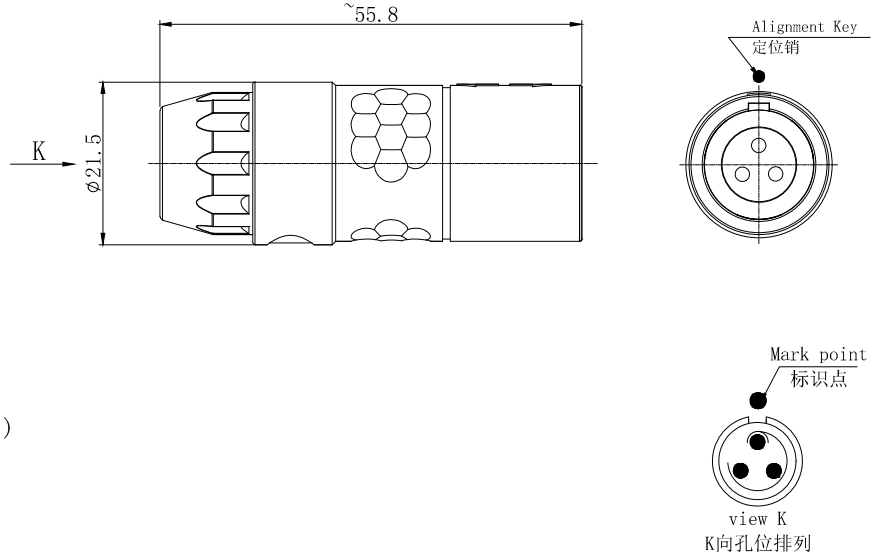

DRAWN BY:
绘图:PDO3 2024.05.28
 CHECKED BY:
审核:Z01 2024.05.28
 APPROVED BY:
核准:PDO5 2024.05.28



美易连电子科技(深圳)有限公司
 Meiyilian electronic technology(shenzhen)Co.,Ltd.

GENERAL TOLERANCE
(UNLESS SPECIFIED)
 ≤10 ±0.1
 <10~≤20 ±0.15
 <20~≤50 ±0.3
 Angle ±1°

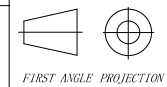

FIRST ANGLE PROJECTION

单位
UNT: mm
 比例
SCALE: 1: 1
 SIZE: A4
 SHEET: 1 OF 1

名称
PART NAME
 型号
PART NAME

PRG-3P浮动式插座(不带护套式尾帽)
 PRG-3P Floating socket
 (without jacketed tail cap)
 PRG. 3P. 303. PLLC85G