

REV/版本	DESCRIPTION/变更内容	DATE/日期	DRAWN BY/绘图

1. Product main performance/产品主要性能指标:

Operating Temperature/工作温度 : -55℃~150℃  
Humidity(max)/最大潮湿 : <=95% [at 60 deg C / 140 F]  
Salt Spray Corrosion/盐雾 : 96hr

Mechanical data/机械特性:

Vibration/振动 : 15g[10Hz~2000Hz]  
Endurance (Shell)/机械寿命 : 2000+

2. 电气性能

Insert Configuration/针芯配置:1P.305 5Low Voltage  
Pin Size/接触件直径:φ0.9mm  
Contact resistance接触电阻:≤9mΩ  
Insulation resistance/绝缘电阻:5000MΩ (测试电压500V(DC))  
Withstand voltage/耐电压:1050V(AC)  
Rated working current额定工作电流:7.0A  
Cable/配接电缆:φ3.5mm-φ4.5mm

Other Specification/其它规格:

Contact PIN/接触体 : Gold plated Tin bronze/锡青铜镀金  
Housing Material/外壳材质 : PSU  
Other Shell Material/其它壳体材质: PSU  
Insulator material/绝缘体材料: PPS  
IP Rating/防护等级 : IP50

\*ALL MATERIALS ARE RoHS COMPLIANT/所有材料均符合RoHS要求.

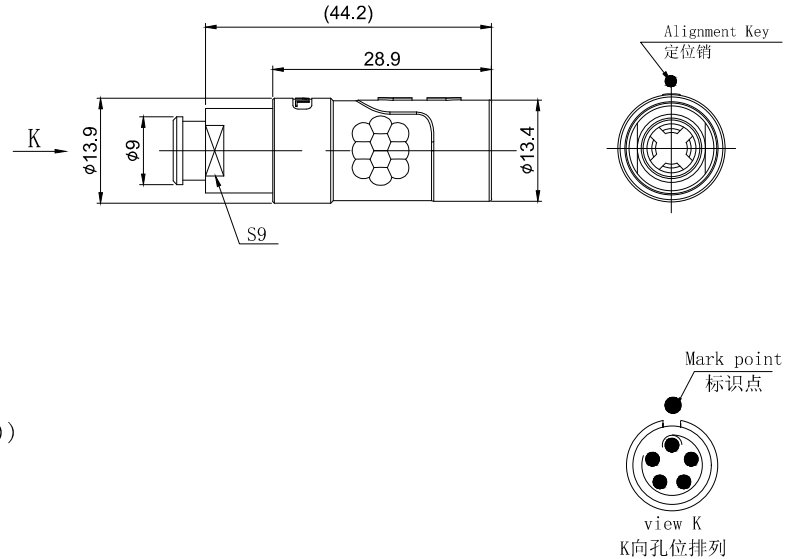

DRAWN BY:  
绘图:PDO3 2024.05.28  
CHECKED BY:  
审核:Z01 2024.05.28  
APPROVED BY:  
核准:PDO5 2024.05.28



美易连电子科技(深圳)有限公司  
Meiyilian electronic technology (shenzhen) Co., Ltd.

GENERAL TOLERANCE  
(UNLESS SPECIFIED)  
≤10 ±0.1  
<10° ≤20 ±0.15  
<20° ≤50 ±0.3  
Angle ±1°

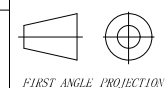

FIRST ANGLE PROJECTION

单位  
UNIT: mm  
比例  
SCALE: 1: 1  
SIZE: A4  
SHEET: 1 OF 1

名称  
PART NAME  
型号  
PART NAME

PRG-1P浮动式插座(带护套式尾帽)  
PRG-1P Floating socket  
(with jacketed tail cap)  
PRG. 1P. 305. PLLC42GZ