

REV/版本	DESCRIPTION/变更内容	DATE/日期	DRAWN BY/绘图

A

A

1. Product main performance/产品主要性能指标:

Operating Temperature/工作温度 : -55℃~150℃
 Humidity(max)/最大潮湿 : <=95% [at 60 deg C / 140 F]
 Salt Spray Corrosion/盐雾 : 96hr

Mechanical data/机械特性:

Vibration/振动 : 15g [10Hz~2000Hz]
 Endurance (Shell)/机械寿命 : 1000+

2. 电气性能

Insert Configuration/针芯配置: 3P. 308 8Low Voltage
 Pin Size/接触件直径: $\phi 1.3\text{mm}$
 Contact resistance接触电阻: $\leq 5\text{m}\Omega$
 Insulation resistance/绝缘电阻: $5000\text{M}\Omega$ (测试电压500V(DC))
 Withstand voltage/耐电压: 1150V(AC)
 Rated working current额定工作电流: 13.0A
 Cable/配接电缆: $\phi 5.5\text{mm}-\phi 6.5\text{mm}$

Other Specification/其它规格:

Contact PIN/接触体 : Gold plated Tin bronze/锡青铜镀金
 Housing Material/外壳材质 : PSU
 Other Shell Material/其它壳体材质: PSU
 Insulator material/绝缘体材料: PPS
 IP Rating/防护等级 : IP61
 *ALL MATERIALS ARE RoHS COMPLIANT/所有材料均符合RoHS要求.

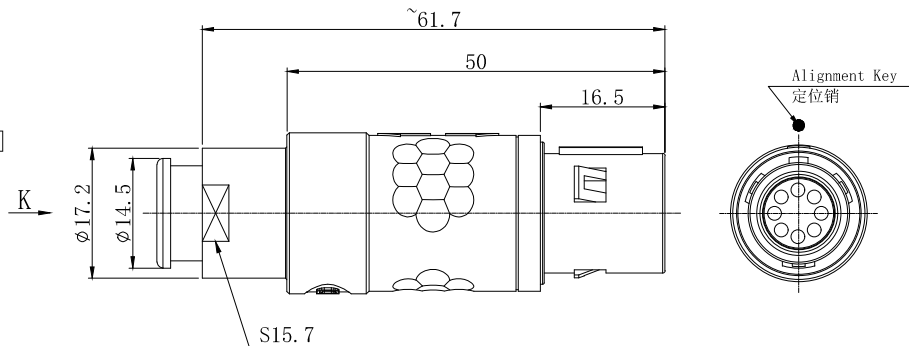

B

B

C

C

D

D

DRAWN BY: 绘图: PDO3 2024. 05. 28 CHECKED BY: 审核: Z01 2024. 05. 28 APPROVED BY: 核准: PDO5 2024. 05. 28		 美易连电子科技(深圳)有限公司 Meiyilian electronic technology (shenzhen) Co., Ltd.	
GENERAL TOLERANCE (UNLESS SPECIFIED) $\leq 10 \pm 0.1$ $< 10 \sim \leq 20 \pm 0.15$ $< 20 \sim \leq 50 \pm 0.3$ Angle $\pm 1^\circ$			
FIRST ANGLE PROJECTION		SIZE: A4 SHEET: 1 OF 1	
REV/版本 A1		型号 PART NAME PAG. 3P. 308. PLAC65GZ	