

1. Product main performance/产品主要性能指标:

Operating Temperature/工作温度 : -55°C~150°C
 Humidity(max)/最大潮湿 : <=95% [at 60 deg C / 140 F]
 Shielding /屏蔽性能 : 75dB(10MHz) 40dB(1GHz)
 Salt Spray Corrosion/盐雾 : 96hr

Mechanical data/机械特性:

Vibration/振动 : 15g[10Hz~2000Hz]
 Shock Resistance/冲击 : 100g[6ms]
 Endurance (Shell)/机械寿命 : 5000+
 Cable/配接电缆: $\phi 5.1\text{mm}-\phi 6.0\text{mm}$

2. 电气性能

Insert Configuration/针芯配置: 1BP. 302 2Low Voltage
 Pin Size/接触件直径: $\phi 1.3\text{mm}$
 Contact resistance接触电阻: $\leq 5\text{m}\Omega$
 Insulation resistance/绝缘电阻: $5000\text{M}\Omega$ (测试电压500V(DC))
 Withstand voltage/耐电压: 1500V(AC)
 Rated working current额定工作电流: 15.0A

Other Specification/其它规格:

Contact PIN/接触体 : Gold plated Tin bronze/锡青铜镀金
 Housing Material/外壳材质 : PEEK
 Other Shell Material/其它壳体材质: 铜镀镍
 Insulator material/绝缘体材料: PEEK
 IP Rating/防护等级 : IP50

*ALL MATERIALS ARE RoHS COMPLIANT/所有材料均符合RoHS要求.

REV/版本	DESCRIPTION/变更内容	DATE/日期	DRAWN BY/绘图

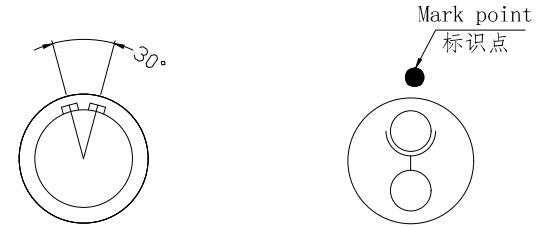
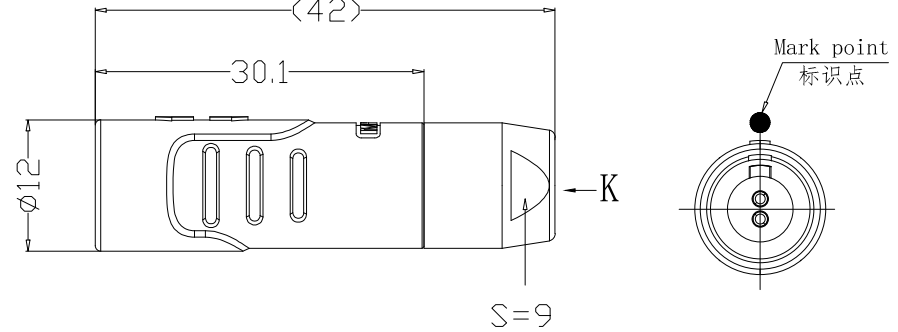

Plug front view
插头前视图

view K
K向孔位排列

DRAWN BY:
绘图: PD03 2024. 05. 28
 CHECKED BY:
审核: Z01 2024. 05. 28
 APPROVED BY:
核准: PD05 2024. 05. 28



美易连电子科技(深圳)有限公司
 Meiyilian electronic technology (shenzhen) Co., Ltd.

GENERAL TOLERANCE
(UNLESS SPECIFIED)
 $\leq 10 \pm 0.1$
 $< 10 \sim \leq 20 \pm 0.15$
 $< 20 \sim \leq 50 \pm 0.3$
 Angle $\pm 1^\circ$

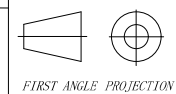

单位
UNTT: mm
 比例
SCALE: 1: 1
 SIZE: A4

名称
PART NAME

DHA-1BP浮动式插座(不带护套式尾帽)
 DHA-1BP Floating socket
 (without jacketed tail cap)

REV/版本 A1

SHEET: 1 OF 1

型号
PART NAME

DHA. 1BP. 302. KWKL.D62