

REV/版本	DESCRIPTION/变更内容	DATE/日期	DRAWN BY/绘图

1. Product main performance/产品主要性能指标:

Operating Temperature/工作温度 : -55°C~200°C  
 Humidity(max)/最大潮湿 : <=95% [at 60 deg C / 140 F]  
 Shielding /屏蔽性能 : 75dB(10MHz) 40dB(1GHz)  
 Salt Spray Corrosion/盐雾 : 96hr  
 P op (max)/最大环境压力 : 60 bar (870 psi)

Mechanical data/机械特性:

Vibration/振动 : 15g[10Hz~2000Hz]  
 Shock Resistance/冲击 : 100g[6ms]  
 Endurance (Shell)/机械寿命 : 5000+

2. 电气性能

Insert Configuration/针芯配置:1U. 303 3Low Voltage  
 Pin Size/接触件直径:Ø1.3mm  
 Contact resistance接触电阻:≤5mΩ  
 Insulation resistance/绝缘电阻:5000MΩ (测试电压500V(DC))  
 Withstand voltage/耐电压:1000V(AC)  
 Rated working current额定工作电流:12.0A  
 Cable/配接电缆:Ø2.1mm-Ø3.0mm

Other Specification/其它规格:

Contact PIN/接触体 :Gold-Tin bronze plating/锡青铜镀金  
 Housing Material/外壳材质 :Pearl-plated chrome brass/黄铜镀珍珠铬  
 Other metal spare parts/其余金属件 : nickel plated brass/黄铜镀镍  
 Insulator material/绝缘材料: PPS  
 IP Rating/防护等级 :IP68(尾部密封防护处理)

\*ALL MATERIALS ARE RoHS COMPLIANT/所有材料均符合RoHS要求.

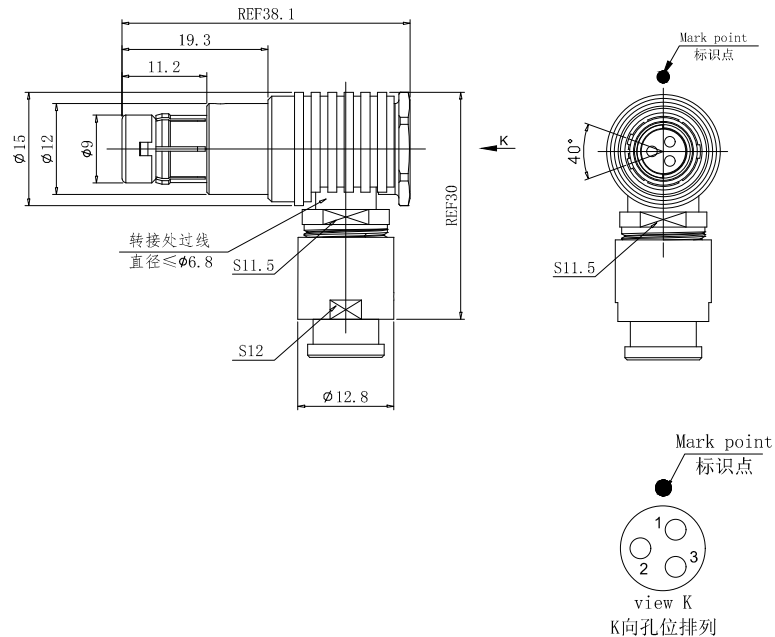

DRAWN BY:  
绘图:PD03 2024.05.28  
 CHECKED BY:  
审核:Z01 2024.05.28  
 APPROVED BY:  
核准:PD05 2024.05.28



美易连电子科技(深圳)有限公司

Meiyilian electronic technology(shenzhen)Co.,Ltd.

GENERAL TOLERANCE  
(UNLESS SPECIFIED)  
 ≤10 ±0.1  
 <10° ≤20 ±0.15  
 <20° ≤50 ±0.3  
 Angle ±1°

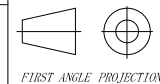

FIRST ANGLE PROJECTION

REV/版本 A1

单位  
UNIT: mm  
 比例  
SCALE: 1: 1  
 SIZE: A4

名称  
PART NAME

型号  
PART NAME

TWA-1U弯角插头(带护套式尾帽)  
TWA-1U Angle Plug  
(with jacketed tail cap)

TWA. 1U. 303. CLAD32Z