

REV/版本	DESCRIPTION/变更内容	DATE/日期	DRAWN BY/绘图

1. Product main performance/产品主要性能指标:
 Operating Temperature/工作温度 : -55°C~125°C
 Humidity(max)/最大潮湿 : <=95% [at 60 deg C / 140 F]
 Shielding /屏蔽性能 : 75dB(10MHz) 40dB(1GHz)
 Salt Spray Corrosion/盐雾 : 96hr
 P op (max)/最大环境压力 : 60 bar (870 psi)

Mechanical data/机械特性:
 Vibration/振动 : 15g[10Hz~2000Hz]
 Shock Resistance/冲击 : 300g[3ms]
 Endurance (Shell)/机械寿命 : 2000次

2. 电气性能

Insert Configuration/针芯配置:2M. 303 3Low Voltage
 Pin Size/接触件直径:φ1.6mm
 Contact resistance接触电阻:≤4mΩ
 Insulation resistance/绝缘电阻:5000MΩ (测试电压500V(DC))
 Withstand voltage/耐电压:1000V(AC)
 Rated working current额定工作电流:17.0A

Other Specification/其它规格:

Contact PIN/接触体 : Gold plated Tin bronze/锡青铜镀金
 Housing Material/外壳材质 : Gun color plated aluminium /铝合金镀枪色
 Other metal spare parts/其余金属件 : Nickel plated brass/铜镀镍
 Glue filling type/灌胶类型: White silica gel/白色硅胶
 Insulator material/绝缘材料: PPS
 IP Rating/防护等级 : IP68(头座配合)

*ALL MATERIALS ARE RoHS COMPLIANT/所有材料均符合RoHS要求.

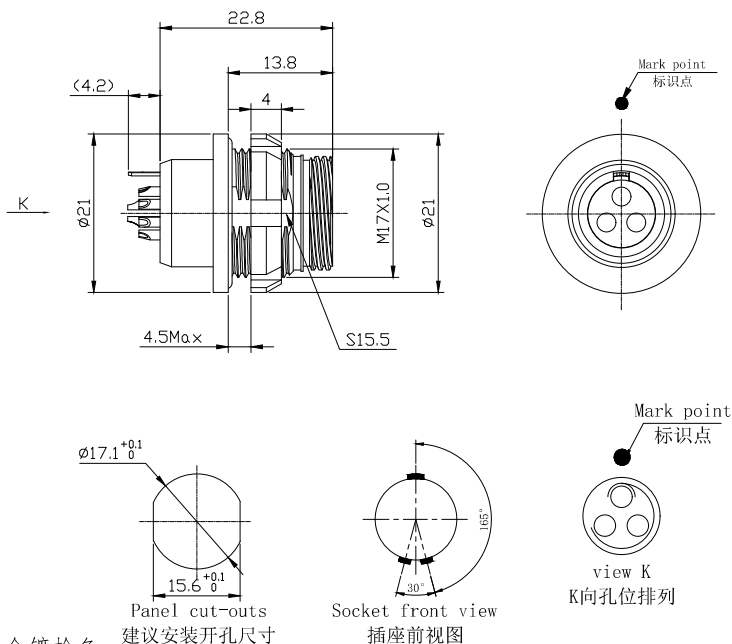

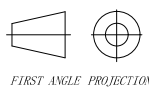
DRAWN BY: 绘图:PD03 2024.05.28		 美易连电子科技(深圳)有限公司 Meiyilian electronic technology(shenzhen)Co.,Ltd.	
CHECKED BY: 审核:Z01 2024.05.28			
APPROVED BY: 核准:PD03 2024.05.28			
GENERAL TOLERANCE (UNLESS SPECIFIED) ≤10 ±0.1 <10~≤20 ±0.15 <20~≤50 ±0.3 Angle ±1°		 FIRST ANGLE PROJECTION	单位 UNTT: mm 名称 PART NAME ZGA-2M固定式插座 ZGA-2M Fixed socket
REV/版本	A1	比例 SCALE: 1: 1 型号 PART NAME ZGA. 2M. 303. XLL	型号 PART NAME ZGA. 2M. 303. XLL