

REV/版本	DESCRIPTION/变更内容	DATE/日期	DRAWN BY/绘图

1. Product main performance/产品主要性能指标:

Operating Temperature/工作温度 : -55℃~200℃
Humidity(max)/最大潮湿 : <=95% [at 60 deg C / 140 F]
Shielding /屏蔽性能 : 75dB(10MHz) 40dB(1GHz)
Salt Spray Corrosion/盐雾 : 96hr
P op (max)/最大环境压力 : 60 bar (870 psi)

Mechanical data/机械特性:

Vibration/振动 : 15g[10Hz~2000Hz]
Shock Resistance/冲击 : 100g[6ms]
Endurance (Shell)/机械寿命 : 5000+

2. 电气性能

Insert Configuration/针芯配置:0F.303 3Low Voltage
Pin Size/接触件直径:φ0.9mm
Contact resistance接触电阻:≤9mΩ
Insulation resistance/绝缘电阻:5000MΩ (测试电压500V(DC))
Withstand voltage/耐电压:750V(AC)
Rated working current额定工作电流:8.0A
Cable/配接电缆:φ3.1mm-φ4.0mm

Other Specification/其它规格:

Contact PIN/接触体 :Gold-Tin bronze plating/锡青铜镀金
Housing Material/外壳材质 :Pearl-plated chrome brass/黄铜镀珍珠铬
Other metal spare parts/其余金属件 : nickel plated brass/黄铜镀镍
Insulator material/绝缘材料: PPS
IP Rating/防护等级 :IP68(尾部密封防护处理)

*ALL MATERIALS ARE RoHS COMPLIANT/所有材料均符合RoHS要求.

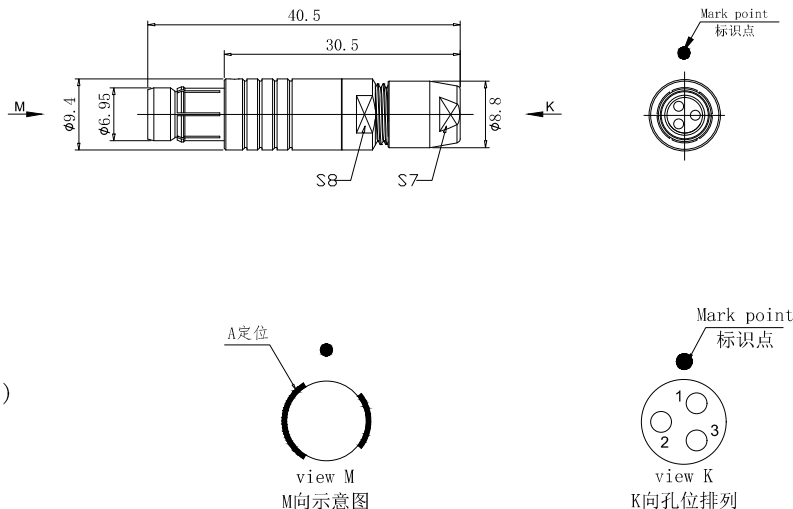

DRAWN BY:
绘图:PDO3 2024.05.28
CHECKED BY:
审核:Z01 2024.05.28
APPROVED BY:
核准:PDO5 2024.05.28



美易连电子科技(深圳)有限公司
Meiyilian electronic technology(shenzhen)Co.,Ltd.

GENERAL TOLERANCE
(UNLESS SPECIFIED)
≤10 ±0.1
<10° ≤20 ±0.15
<20° ≤50 ±0.3
AngIε ±1°



FIRST ANGLE PROJECTION

单位
UNTT: mm
比例
SCALE: 1: 1
SIZE: A4
SHEET: 1 OF 1

名称
PART NAME
型号
PART NAME

TGA-0F直式插头(不带护套式尾帽)
TGA-0F Straight Plug
(without jacketed tail cap)
TGA. 0F. 303. CLAD42