

REV/版本	DESCRIPTION/变更内容	DATE/日期	DRAWN BY/绘图

1. Product main performance/产品主要性能指标:

Operating Temperature/工作温度 : -55℃~200℃
 Humidity(max)/最大潮湿 : <=95% [at 60 deg C / 140 F]
 Shielding /屏蔽性能 : 75dB(10MHz) 40dB(1GHz)
 Salt Spray Corrosion/盐雾 : 96hr
 P op (max)/最大环境压力 : 60 bar (870 psi)

Mechanical data/机械特性:

Vibration/振动 : 15g[10Hz~2000Hz]
 Shock Resistance/冲击 : 100g[6ms]
 Endurance (Shell)/机械寿命 : 5000+

2. 电气性能

Insert Configuration/针芯配置: 2F. 318 18Low Voltage
 Pin Size/接触件直径: $\phi 0.7\text{mm}$
 Contact resistance接触电阻: $\leq 12.5\text{m}\Omega$
 Insulation resistance/绝缘电阻: 5000M Ω (测试电压500V(DC))
 Withstand voltage/耐电压: 875V(AC)
 Rated working current额定工作电流: 5.5A
 Cable/配接电缆: $\phi 6.1\text{mm}-\phi 7.0\text{mm}$

Other Specification/其它规格:

Contact PIN/接触体 : Gold plated Tin bronze/锡青铜镀金
 Housing Material/外壳材质 : black chrome plated brass/铜镀黑铬
 Other metal spare parts/其余金属件 : Nickel plated brass/铜镀镍
 Insulator material/绝缘材料: PPS
 IP Rating/防护等级 : IP68(插合状态)
 *ALL MATERIALS ARE RoHS COMPLIANT/所有材料均符合RoHS要求.

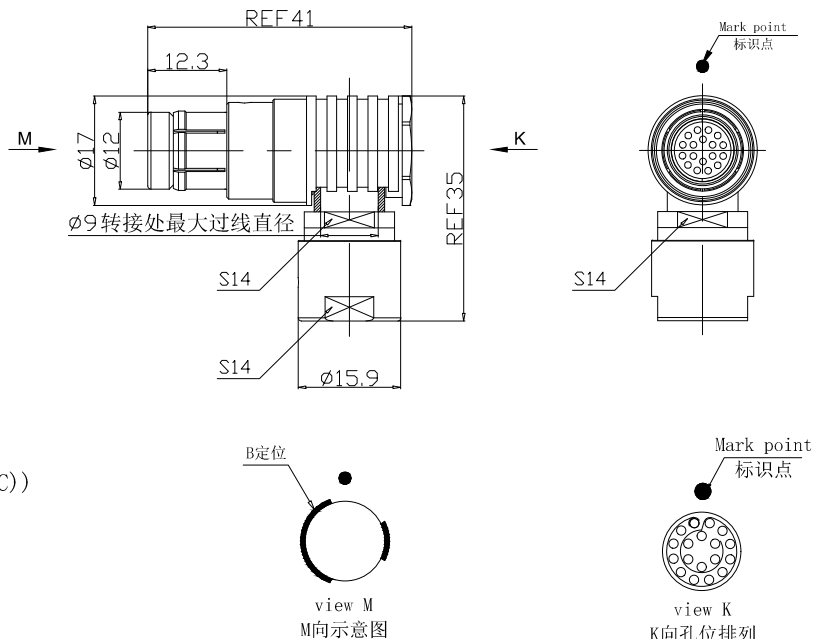

DRAWN BY:
 绘图: PD03 2024. 05. 28
 CHECKED BY:
 审核: Z01 2024. 05. 28
 APPROVED BY:
 核准: PD05 2024. 05. 28



美易连电子科技(深圳)有限公司
 Meiyilian electronic technology(shenzhen)Co.,Ltd.

GENERAL TOLERANCE
 (UNLESS SPECIFIED)
 $\leq 10 \pm 0.1$
 $< 10 \sim \leq 20 \pm 0.15$
 $< 20 \sim \leq 50 \pm 0.3$
 Angle $\pm 1^\circ$



单位
 UNIT: mm
 比例
 SCALE: 1: 1
 型号
 PART NAME

名称
 PART NAME

TWB-2F弯角插头(不带护套式尾帽)
 TWB-2F Angle Plug
 (without jacketed tail cap)
 型号
 PART NAME
 TWB. 2F. 318. KLD72

REV/版本 A1

SHEET: 1 OF 1