

REV/版本	DESCRIPTION/变更内容	DATE/日期	DRAWN BY/绘图

1. Product main performance/产品主要性能指标:

Operating Temperature/工作温度 : -55°C~200°C  
 Humidity(max)/最大潮湿 : <=95% [at 60 deg C / 140 F]  
 Shielding /屏蔽性能 : 75dB(10MHz) 40dB(1GHz)  
 Salt Spray Corrosion/盐雾 : 96hr  
 P op (max)/最大环境压力 : 60 bar (870 psi)

Mechanical data/机械特性:  
 Vibration/振动 : 15g[10Hz~2000Hz]  
 Shock Resistance/冲击 : 100g[6ms]  
 Endurance (Shell)/机械寿命 : 5000+

2. 电气性能

Insert Configuration/针芯配置:2F.303 3Low Voltage  
 Pin Size/接触件直径:φ1.6mm  
 Contact resistance接触电阻:≤4mΩ  
 Insulation resistance/绝缘电阻:5000MΩ (测试电压500V(DC))  
 Withstand voltage/耐电压:1000V(AC)  
 Rated working current额定工作电流:17.0A  
 Cable/配接电缆:φ8.1mm-φ9.0mm

Other Specification/其它规格:

Contact PIN/接触体 : Gold plated Tin bronze/锡青铜镀金  
 Housing Material/外壳材质 : Pearl-plated chrome brass/铜镀珍珠铬  
 Other metal spare parts/其余金属件 : Nickel plated brass/铜镀镍  
 Insulator material/绝缘材料: PPS  
 IP Rating/防护等级 : IP68(插合状态)  
 \*ALL MATERIALS ARE RoHS COMPLIANT/所有材料均符合RoHS要求.

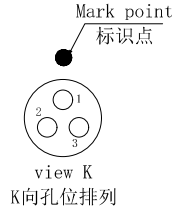
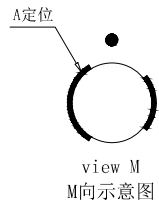
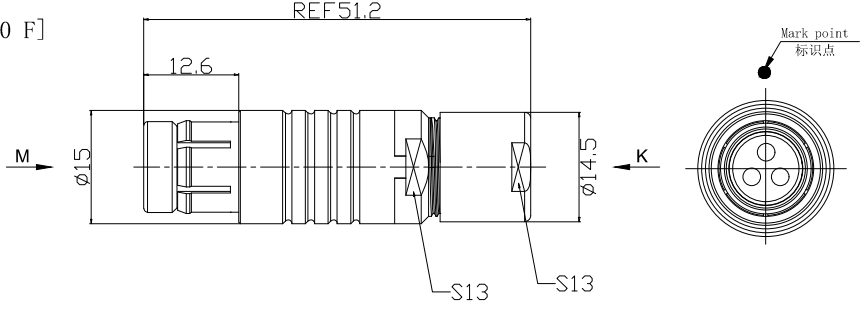

A

B

C

D

A

B

C

D

DRAWN BY:  
绘图:PD03 2024.05.28  
CHECKED BY:  
审核:Z01 2024.05.28  
APPROVED BY:  
核准:PD05 2024.05.28



美易连电子科技(深圳)有限公司  
 Meiyilian electronic technology(shenzhen)Co.,Ltd.

GENERAL TOLERANCE (UNLESS SPECIFIED)  
 ≤10 ±0.1  
 <10~≤20 ±0.15  
 <20~≤50 ±0.3  
 Angle ±1°

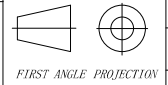

单位  
UNIT: mm  
比例  
SCALE: 1: 1

名称  
PART NAME

TGA-2F直式插头(不带护套式尾帽)  
 TGA-2F Straight Plug  
 (without jacketed tail cap)

型号  
PART NAME

TGA. 2F. 303. CLAD92

REV/版本 A1

SHEET: 1 OF 1