

REV/版本	DESCRIPTION/变更内容	DATE/日期	DRAWN BY/绘图

1. Product main performance/产品主要性能指标:

Operating Temperature/工作温度 : -55℃~200℃  
 Humidity(max)/最大潮湿 : <=95% [at 60 deg C / 140 F]  
 Shielding /屏蔽性能 : 75dB(10MHz) 40dB(1GHz)  
 Salt Spray Corrosion/盐雾 : 96hr  
 P op (max)/最大环境压力 : 60 bar (870 psi)

Mechanical data/机械特性:

Vibration/振动 : 15g[10Hz~2000Hz]  
 Shock Resistance/冲击 : 100g[6ms]  
 Endurance (Shell)/机械寿命 : 5000+

2. 电气性能

Insert Configuration/针芯配置: 2F. 312 12Low Voltage  
 Pin Size/接触件直径:  $\phi 0.7\text{mm}$   
 Contact resistance接触电阻:  $\leq 12.5\text{m}\Omega$   
 Insulation resistance/绝缘电阻: 5000M $\Omega$  (测试电压500V(DC))  
 Withstand voltage/耐电压: 875V(AC)  
 Rated working current额定工作电流: 7.0A  
 Cable/配接电缆:  $\phi 4.1\text{mm}-\phi 5.0\text{mm}$

Other Specification/其它规格:

Contact PIN/接触体 : Gold plated Tin bronze/锡青铜镀金  
 Housing Material/外壳材质 : Pearl-plated chrome brass/铜镀珍珠铬  
 Other metal spare parts/其余金属件 : Nickel plated brass/铜镀镍  
 Insulator material/绝缘材料: PPS  
 IP Rating/防护等级 : IP68(插合状态)  
 \*ALL MATERIALS ARE RoHS COMPLIANT/所有材料均符合RoHS要求.

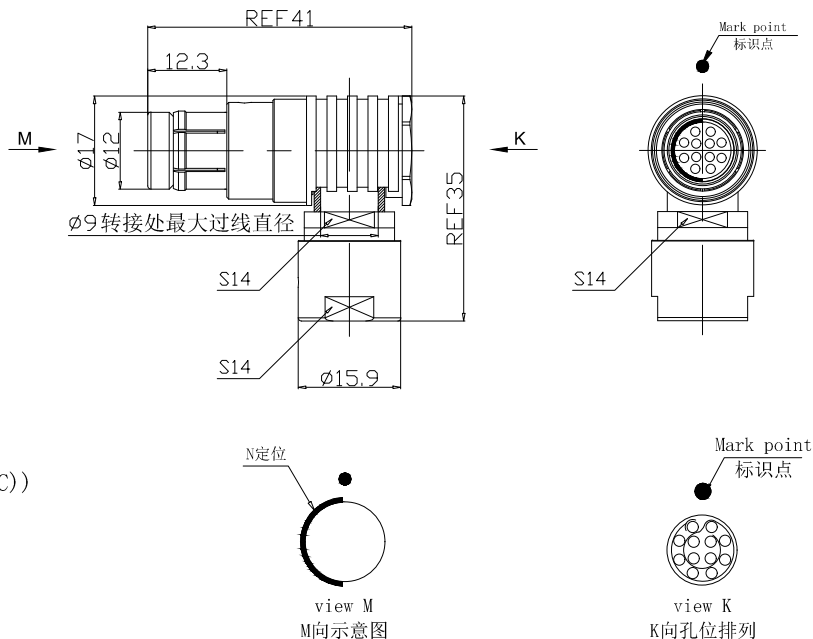

DRAWN BY:  
绘图: PD03 2024. 05. 28  
 CHECKED BY:  
审核: Z01 2024. 05. 28  
 APPROVED BY:  
核准: PD05 2024. 05. 28



美易连电子科技(深圳)有限公司

Meiyilian electronic technology(shenzhen)Co.,Ltd.

GENERAL TOLERANCE  
(UNLESS SPECIFIED)  
 $\leq 10 \pm 0.1$   
 $< 10 \sim \leq 20 \pm 0.15$   
 $< 20 \sim \leq 50 \pm 0.3$   
 Angle  $\pm 1^\circ$

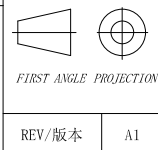

单位  
UNIT: mm  
 比例  
SCALE: 1: 1  
 尺寸  
SIZE: A4  
 REV/版本 A1 SHEET: 1 OF 1

名称  
PART NAME  
 型号  
PART NAME

TWN-2F弯角插头(不带护套式尾帽)  
 TWN-2F Angle Plug  
 (without jacketed tail cap)  
 TWN. 2F. 312. CLAD52-2B