

REV/版本	DESCRIPTION/变更内容	DATE/日期	DRAWN BY/绘图

1. Product main performance/产品主要性能指标:

Operating Temperature/工作温度 : -55°C~200°C
 Humidity(max)/最大潮湿 : <=95% [at 60 deg C / 140 F]
 Shielding /屏蔽性能 : 75dB(10MHz) 40dB(1GHz)
 Salt Spray Corrosion/盐雾 : 96hr
 P op (max)/最大环境压力 : 60 bar (870 psi)

Mechanical data/机械特性:

Vibration/振动 : 15g[10Hz~2000Hz]
 Shock Resistance/冲击 : 100g[6ms]
 Endurance (Shell)/机械寿命 : 5000+

2. 电气性能

Insert Configuration/针芯配置:1F.305 5Low Voltage
 Pin Size/接触件直径:φ0.9mm
 Contact resistance接触电阻:≤9mΩ
 Insulation resistance/绝缘电阻:5000MΩ (测试电压500V(DC))
 Withstand voltage/耐电压:875V(AC)
 Rated working current额定工作电流:9.0A
 Cable/配接电缆:φ2.1mm-φ3.0mm

Other Specification/其它规格:

Contact PIN/接触体 :Gold-Tin bronze plating/锡青铜镀金
 Housing Material/外壳材质 :black chrome plated brass/黄铜镀黑铬
 Other metal spare parts/其余金属件 : nickel plated brass/黄铜镀镍
 Insulator material/绝缘材料: PPS
 IP Rating/防护等级 :IP68(尾部密封防护处理)
 *ALL MATERIALS ARE RoHS COMPLIANT/所有材料均符合RoHS要求.

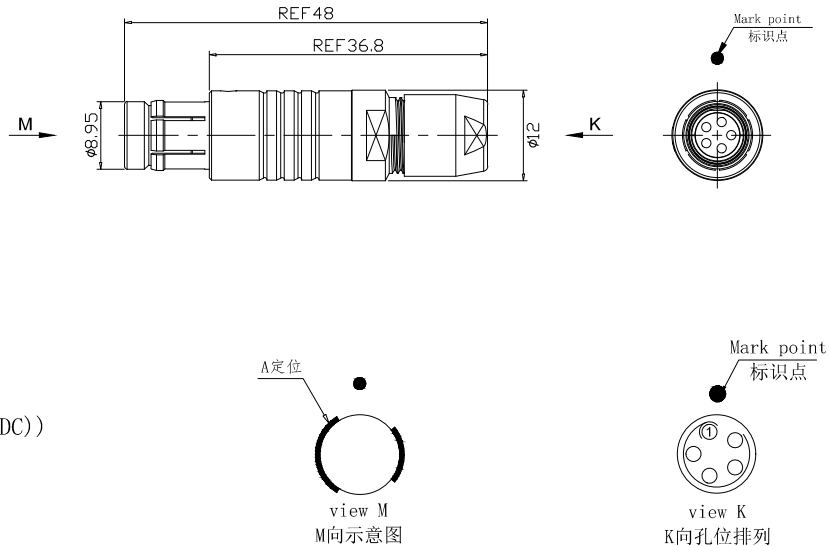

DRAWN BY: 绘图:PD03	2024.05.28
CHECKED BY: 审核:Z01	2024.05.28
APPROVED BY: 核准:PD05	2024.05.28



美易连电子科技(深圳)有限公司
 Meiyilian electronic technology(shenzhen)Co.,Ltd.

GENERAL TOLERANCE (UNLESS SPECIFIED)	≤10 ±0.1 <10~≤20 ±0.15 <20~≤50 ±0.3 Angle ±1°
---	--

	FIRST ANGLE PROJECTION
REV/版本	A1

单位 UNIT: mm	名称 PART NAME
比例 SCALE: 1: 1	型号 PART NAME
SIZE: A4	SHEET: 1 OF 1

TGA-1F直式插头(不带护套式尾帽) TGA-1F Straight Plug (without jacketed tail cap)	TGA. 1F. 305. Klad32
--	----------------------