

REV/版本	DESCRIPTION/变更内容	DATE/日期	DRAWN BY/绘图

1. Product main performance/产品主要性能指标:

Operating Temperature/工作温度 : -55°C~200°C  
 Humidity(max)/最大潮湿 : <=95% [at 60 deg C / 140 F]  
 Shielding /屏蔽性能 : 75dB(10MHz) 40dB(1GHz)  
 Salt Spray Corrosion/盐雾 : 96hr  
 P op (max)/最大环境压力 : 60 bar (870 psi)

Mechanical data/机械特性:

Vibration/振动 : 15g[10Hz~2000Hz]  
 Shock Resistance/冲击 : 100g[6ms]  
 Endurance (Shell)/机械寿命 : 5000+

2. 电气性能

Insert Configuration/针芯配置:1F.302 2Low Voltage  
 Pin Size/接触件直径:φ1.3mm  
 Contact resistance接触电阻:≤5mΩ  
 Insulation resistance/绝缘电阻:5000MΩ (测试电压500V(DC))  
 Withstand voltage/耐电压:1000V(AC)  
 Rated working current额定工作电流:12.0A  
 Cable/配接电缆:φ3.1mm-φ4.0mm

Other Specification/其它规格:

Contact PIN/接触体 :Gold-Tin bronze plating/锡青铜镀金  
 Housing Material/外壳材质 :black chrome plated brass/黄铜镀黑铬  
 Other metal spare parts/其余金属件 : nickel plated brass/黄铜镀镍  
 Insulator material/绝缘材料: PPS  
 IP Rating/防护等级 :IP68(尾部密封防护处理)  
 \*ALL MATERIALS ARE RoHS COMPLIANT/所有材料均符合RoHS要求.

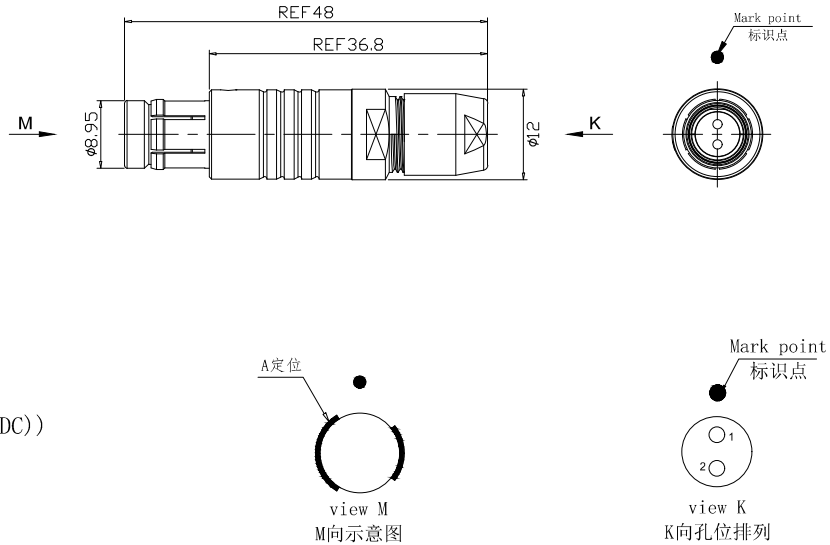

DRAWN BY: 绘图:PDO3	2024.05.28
CHECKED BY: 审核:Z01	2024.05.28
APPROVED BY: 核准:PDO5	2024.05.28



美易连电子科技(深圳)有限公司  
 Meiyilian electronic technology(shenzhen)Co.,Ltd.

GENERAL TOLERANCE (UNLESS SPECIFIED)	≤10 ±0.1 <10~≤20 ±0.15 <20~≤50 ±0.3 Angle ±1°
FIRST ANGLE PROJECTION	
REV/版本	A1

单位 UNIT: mm	名称 PART NAME	TGA-1F 直式插头 (不带护套式尾帽) TGA-1F Straight Plug (without jacketed tail cap)
比例 SCALE: 1: 1	型号 PART NAME	TGA. 1F. 302. KLAD42
SIZE: A4	SHEET: 1 OF 1	