

REV/版本	DESCRIPTION/变更内容	DATE/日期	DRAWN BY/绘图

1. Product main performance/产品主要性能指标:

Operating Temperature/工作温度 : -55℃~200℃
 Humidity(max)/最大潮湿 : <=95% [at 60 deg C / 140 F]
 Shielding /屏蔽性能 : 75dB(10MHz) 40dB(1GHz)
 Salt Spray Corrosion/盐雾 : 96hr
 P op (max)/最大环境压力 : 60 bar (870 psi)

Mechanical data/机械特性:

Vibration/振动 : 15g[10Hz~2000Hz]
 Shock Resistance/冲击 : 100g[6ms]
 Endurance (Shell)/机械寿命 : 5000+

2. 电气性能

Insert Configuration/针芯配置:3F.316 16Low Voltage
 Pin Size/接触件直径:φ0.9mm
 Contact resistance接触电阻:≤9mΩ
 Insulation resistance/绝缘电阻:5000MΩ (测试电压500V(DC))
 Withstand voltage/耐电压:850V(AC)
 Rated working current额定工作电流:8.0A
 Cable/配接电缆:φ6.1mm-φ7.0mm

Other Specification/其它规格:

Contact PIN/接触体 : Gold plated Tin bronze/锡青铜镀金
 Housing Material/外壳材质 : Pearl-plated chrome brass/铜镀珍珠铬
 Other metal spare parts/其余金属件 : Nickel plated brass/铜镀镍
 Insulator material/绝缘材料: PPS
 IP Rating/防护等级 : IP68(插合状态)

*ALL MATERIALS ARE RoHS COMPLIANT/所有材料均符合RoHS要求.

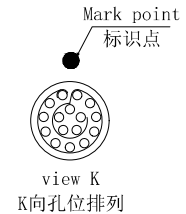
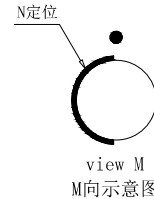
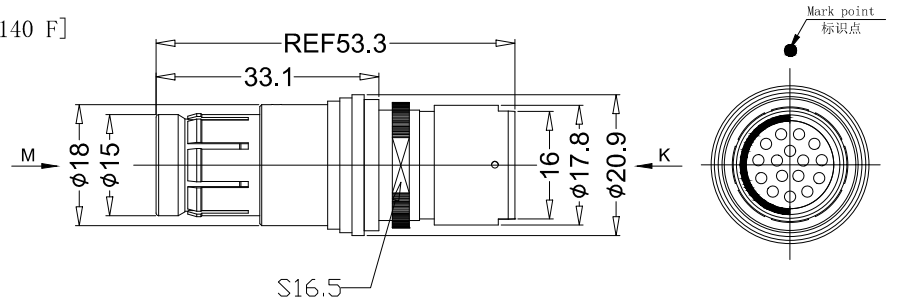

DRAWN BY:
绘图:PD03 2024.05.28
 CHECKED BY:
审核:Z01 2024.05.28
 APPROVED BY:
核准:PD05 2024.05.28



美易连电子科技(深圳)有限公司
 Meiyilian electronic technology(shenzhen)Co.,Ltd.

GENERAL TOLERANCE
(UNLESS SPECIFIED)
 ≤10 ±0.1
 <10°~≤20 ±0.15
 <20°~≤50 ±0.3
 Angle ±1°



REV/版本 A1

单位
UNIT: mm
 比例
SCALE: 1: 1
 型号
PART NAME

名称
PART NAME
 TLN-3F直式插头(不带护套式尾帽)
 TLN-3F Straight Plug
 (without jacketed tail cap)
 型号
PART NAME
 TLN. 3F. 316. CLAD72-3B