

REV/版本	DESCRIPTION/变更内容	DATE/日期	DRAWN BY/绘图

1. Product main performance/产品主要性能指标:

Operating Temperature/工作温度 : -55°C~200°C  
Humidity(max)/最大潮湿 : <=95% [at 60 deg C / 140 F]  
Shielding /屏蔽性能 : 75dB(10MHz) 40dB(1GHz)  
Salt Spray Corrosion/盐雾 : 96hr  
P op (max)/最大环境压力 : 60 bar (870 psi)

Mechanical data/机械特性:

Vibration/振动 : 15g[10Hz~2000Hz]  
Shock Resistance/冲击 : 100g[6ms]  
Endurance (Shell)/机械寿命 : 5000+

2. 电气性能

Insert Configuration/针芯配置:3F.305 5Low Voltage  
Pin Size/接触件直径:φ1.6mm  
Contact resistance接触电阻:≤4mΩ  
Insulation resistance/绝缘电阻:5000MΩ (测试电压500V(DC))  
Withstand voltage/耐电压:1250V(AC)  
Rated working current额定工作电流:19.0A  
Cable/配接电缆:φ7.1mm-φ8.0mm

Other Specification/其它规格:

Contact PIN/接触体 : Gold plated Tin bronze/锡青铜镀金  
Housing Material/外壳材质 : Pearl-plated chrome brass/铜镀珍珠铬  
Other metal spare parts/其余金属件 : Nickel plated brass/铜镀镍  
Insulator material/绝缘材料: PPS  
IP Rating/防护等级 : IP68(插合状态)

\*ALL MATERIALS ARE RoHS COMPLIANT/所有材料均符合RoHS要求.

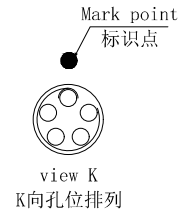
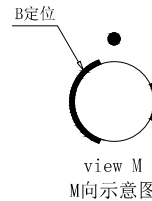
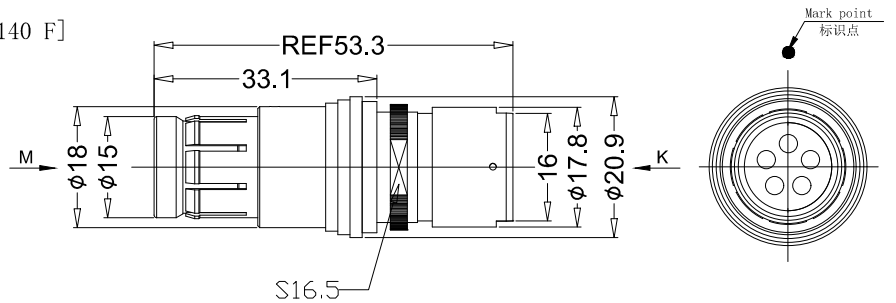

DRAWN BY:  
绘图:PD03 2024.05.28  
CHECKED BY:  
审核:Z01 2024.05.28  
APPROVED BY:  
核准:PD05 2024.05.28



美易连电子科技(深圳)有限公司  
Meiyilian electronic technology(shenzhen)Co.,Ltd.

GENERAL TOLERANCE  
(UNLESS SPECIFIED)  
≤10 ±0.1  
<10° ≤20 ±0.15  
<20° ≤50 ±0.3  
Angle ±1°

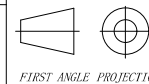

REV/版本 A1

单位  
UNIT: mm  
比例  
SCALE: 1: 1

SIZE: A4

SHEET: 1 OF 1

名称  
PART NAME

型号  
PART NAME

TLB-3F直式插头(不带护套式尾帽)  
TLB-3F Straight Plug  
(without jacketed tail cap)

TLB. 3F. 305. CLAD82-3B