

REV/版本	DESCRIPTION/变更内容	DATE/日期	DRAWN BY/绘图

1. Product main performance/产品主要性能指标:

Operating Temperature/工作温度 : -55℃~200℃
 Humidity(max)/最大潮湿 : <=95% [at 60 deg C / 140 F]
 Shielding /屏蔽性能 : 75dB(10MHz) 40dB(1GHz)
 Salt Spray Corrosion/盐雾 : 96hr
 P op (max)/最大环境压力 : 60 bar (870 psi)

Mechanical data/机械特性:

Vibration/振动 : 15g[10Hz~2000Hz]
 Shock Resistance/冲击 : 100g[6ms]
 Endurance (Shell)/机械寿命 : 5000+

2. 电气性能

Insert Configuration/针芯配置:3F.309 9Low Voltage
 Pin Size/接触件直径:φ2.0mm/φ1.3mm
 Contact resistance接触电阻:≤3.5mΩ/5mΩ
 Insulation resistance/绝缘电阻:5000MΩ (测试电压500V(DC))
 Withstand voltage/耐电压:1050V(AC)
 Rated working current额定工作电流:15.0A/6.0A
 Cable/配接电缆:φ6.1mm-φ7.0mm

Other Specification/其它规格:

Contact PIN/接触体 : Gold plated Tin bronze/锡青铜镀金
 Housing Material/外壳材质 : Pearl-plated chrome brass/铜镀珍珠铬
 Other metal spare parts/其余金属件 : Nickel plated brass/铜镀镍
 Insulator material/绝缘材料: PPS
 IP Rating/防护等级 : IP68(插合状态)

*ALL MATERIALS ARE RoHS COMPLIANT/所有材料均符合RoHS要求.

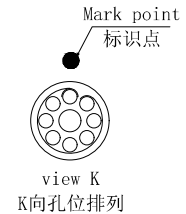
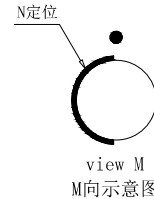
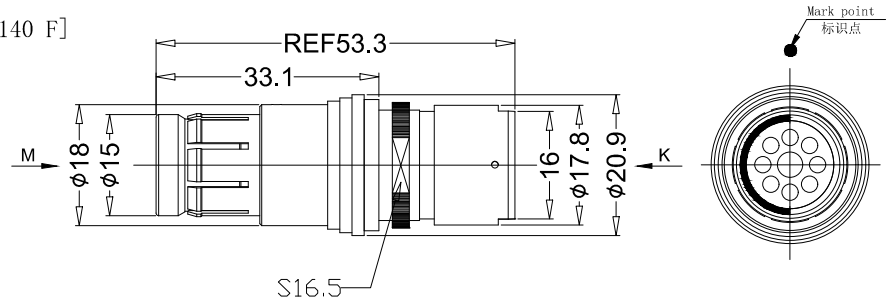

DRAWN BY: 绘图:PD03 2024.05.28		 美易连电子科技(深圳)有限公司 Meiyilian electronic technology (shenzhen) Co., Ltd.		
CHECKED BY: 审核:Z01 2024.05.28			名称 PART NAME	TLN-3F 直式插头 (不带护套式尾帽) TLN-3F Straight Plug (without jacketed tail cap)
APPROVED BY: 核准:PD05 2024.05.28			比例 SCALE: 1: 1	型号 PART NAME
GENERAL TOLERANCE (UNLESS SPECIFIED) ≤10 ±0.1 <10°~≤20 ±0.15 <20°~≤50 ±0.3 Angle ±1°		单位 UNIT: mm 比例 SCALE: 1: 1 型号 PART NAME TLN. 3F. 309. CLAD72-3B		
REV/版本	A1	SHEET: 1 OF 1		