

REV/版本	DESCRIPTION/变更内容	DATE/日期	DRAWN BY/绘图

I. Product main performance/产品主要性能指标:

Operating Temperature/工作温度 : -55°C~200°C
 Humidity(max)/最大潮湿 : <=95% [at 60 deg C / 140 F]
 Shielding /屏蔽性能 : 75dB(10MHz) 40dB(1GHz)
 Salt Spray Corrosion/盐雾 : 96hr
 P op (max)/最大环境压力 : 60 bar (870 psi)

Mechanical data/机械特性:

Vibration/振动 : 15g[10Hz~2000Hz]
 Shock Resistance/冲击 : 100g[6ms]
 Endurance (Shell)/机械寿命 : 5000+

2. 电气性能

Insert Configuration/针芯配置:2F.319 19Low Voltage
 Pin Size/接触件直径:Ø0.7mm
 Contact resistance接触电阻:≤12.5mΩ
 Insulation resistance/绝缘电阻:5000MΩ (测试电压500V(DC))
 Withstand voltage/耐电压:750V(AC)
 Rated working current额定工作电流:5.0A
 Cable/配接电缆:Ø4.1mm-Ø5.0mm

Other Specification/其它规格:

Contact PIN/接触体 : Gold plated Tin bronze/锡青铜镀金
 Housing Material/外壳材质 : black chrome plated brass/铜镀黑铬
 Other metal spare parts/其余金属件 : Nickel plated brass/铜镀镍
 Insulator material/绝缘材料: PPS
 IP Rating/防护等级 : IP68(插合状态)
 *ALL MATERIALS ARE RoHS COMPLIANT/所有材料均符合RoHS要求.

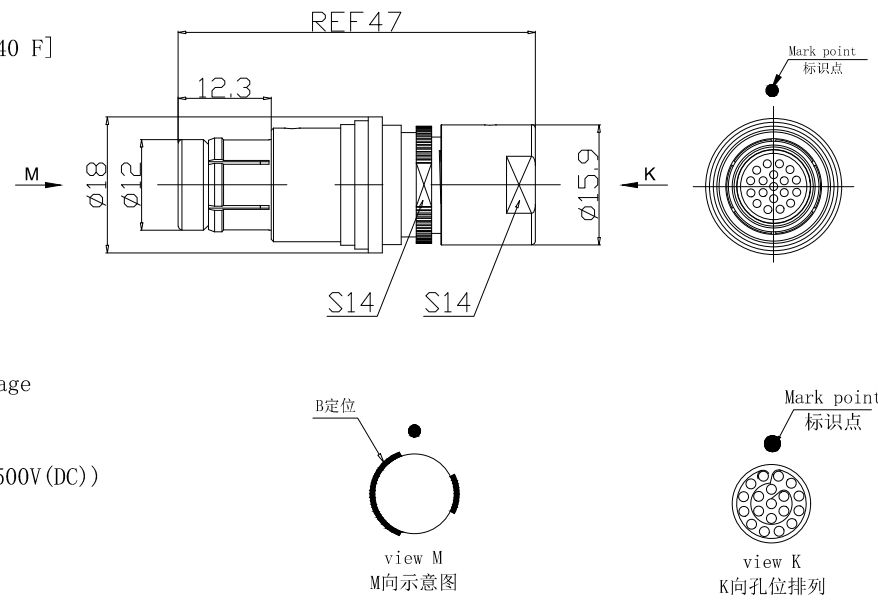

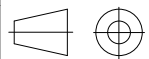
DRAWN BY: 绘图:PDO3 2024.05.28		 美易连电子科技(深圳)有限公司 Meiyilian electronic technology(shenzhen)Co.,Ltd.	名称 PART NAME		TLB-2F直式插头(不带护套式尾帽) TLB-2F Straight Plug (without jacketed tail cap)	
CHECKED BY: 审核:Z01 2024.05.28			比例 SCALE: 1: 1	型号 PART NAME		TLB. 2F. 319. KLAB52
APPROVED BY: 核准:PDO5 2024.05.28			SIZE: A4	SHEET: 1 OF 1		
GENERAL TOLERANCE (UNLESS SPECIFIED) ≤10 ±0.1 <10° ≤20 ±0.15 <20° ≤50 ±0.3 Angle ±1°		 FIRST ANGLE PROJECTION	REV/版本	A1		