

REV/版本	DESCRIPTION/变更内容	DATE/日期	DRAWN BY/绘图

1. Product main performance/产品主要性能指标:

Operating Temperature/工作温度 : -55℃~200℃  
 Humidity(max)/最大潮湿 : <=95% [at 60 deg C / 140 F]  
 Shielding /屏蔽性能 : 75dB(10MHz) 40dB(1GHz)  
 Salt Spray Corrosion/盐雾 : 96hr  
 P op (max)/最大环境压力 : 60 bar (870 psi)

Mechanical data/机械特性:

Vibration/振动 : 15g[10Hz~2000Hz]  
 Shock Resistance/冲击 : 100g[6ms]  
 Endurance (Shell)/机械寿命 : 5000+

2. 电气性能

Insert Configuration/针芯配置:1U.306 6Low Voltage  
 Pin Size/接触件直径:∅0.7mm  
 Contact resistance接触电阻:≤12.5mΩ  
 Insulation resistance/绝缘电阻:5000MΩ (测试电压500V(DC))  
 Withstand voltage/耐电压:875V(AC)  
 Rated working current额定工作电流:7.0A  
 Cable/配接电缆:∅2.4mm-∅3.3mm

Other Specification/其它规格:

Contact PIN/接触体 :Gold-Tin bronze plating/锡青铜镀金  
 Housing Material/外壳材质 :Pearl-plated chrome brass/黄铜镀珍珠铬  
 Other metal spare parts/其余金属件 : nickel plated brass/黄铜镀镍  
 Insulator material/绝缘材料: PPS  
 IP Rating/防护等级 :IP68(尾部密封防护处理)

\*ALL MATERIALS ARE RoHS COMPLIANT/所有材料均符合RoHS要求.

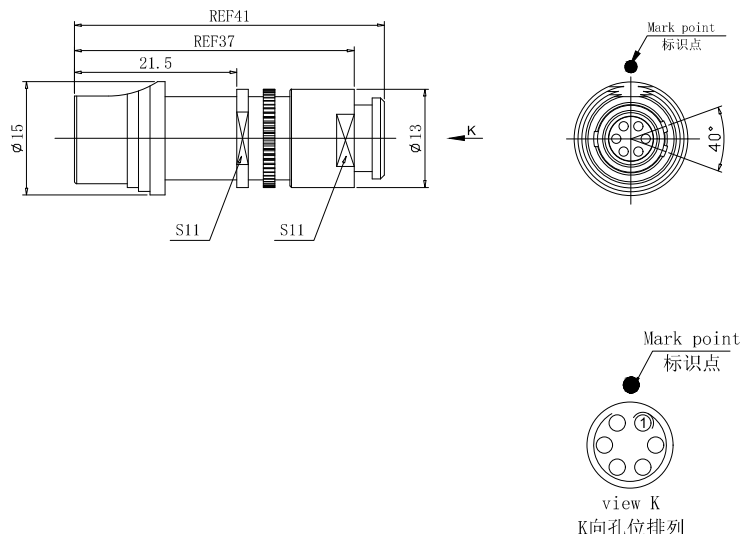

A

A

B

B

C

C

D

D

DRAWN BY:  
 绘图:PD03 2024.05.28  
 CHECKED BY:  
 审核:Z01 2024.05.28  
 APPROVED BY:  
 核准:PD05 2024.05.28



美易连电子科技(深圳)有限公司

Meiyilian electronic technology(shenzhen)Co.,Ltd.

GENERAL TOLERANCE  
 (UNLESS SPECIFIED)  
 ≤10 ±0.1  
 <10~≤20 ±0.15  
 <20~≤50 ±0.3  
 Angle ±1°

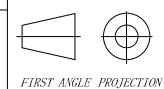

单位  
 UNIT: mm  
 比例  
 SCALE: 1: 1

名称  
 PART NAME

DHA-1U浮动式插座(带护套式尾帽)  
 DHA-1U Floating socket  
 (with jacketed tail cap)

SIZE: A4  
 SHEET: 1 OF 1

型号  
 PART NAME

DHA. 1U. 306. CLLD35Z

REV/版本

A1