

REV/版本	DESCRIPTION/变更内容	DATE/日期	DRAWN BY/绘图

1. Product main performance/产品主要性能指标:

Operating Temperature/工作温度 : -55°C~200°C  
 Humidity(max)/最大潮湿 : <=95% [at 60 deg C / 140 F]  
 Shielding /屏蔽性能 : 75dB(10MHz) 40dB(1GHz)  
 Salt Spray Corrosion/盐雾 : 96hr  
 P op (max)/最大环境压力 : 60 bar (870 psi)

Mechanical data/机械特性:

Vibration/振动 : 15g[10Hz~2000Hz]  
 Shock Resistance/冲击 : 100g[6ms]  
 Endurance (Shell)/机械寿命 : 5000+

2. 电气性能

Insert Configuration/针芯配置:3K.304 4Low Voltage  
 Pin Size/接触件直径:φ2.0mm  
 Contact resistance接触电阻:≤3.5mΩ  
 Insulation resistance/绝缘电阻:5000MΩ (测试电压500V(DC))  
 Withstand voltage/耐电压:875V(AC)  
 Rated working current额定工作电流:19.0A

Other Specification/其它规格:

Contact PIN/接触体 : Gold plated Tin bronze/锡青铜镀金  
 Housing Material/外壳材质 : Chrome plated brass/铜镀珍珠铬  
 Other metal spare parts/其余金属件 : Nickel plated brass/铜镀镍  
 Insulator material/绝缘材料: PPS  
 IP Rating/防护等级 : IP68(头座插合)

\*ALL MATERIALS ARE RoHS COMPLIANT/所有材料均符合RoHS要求.

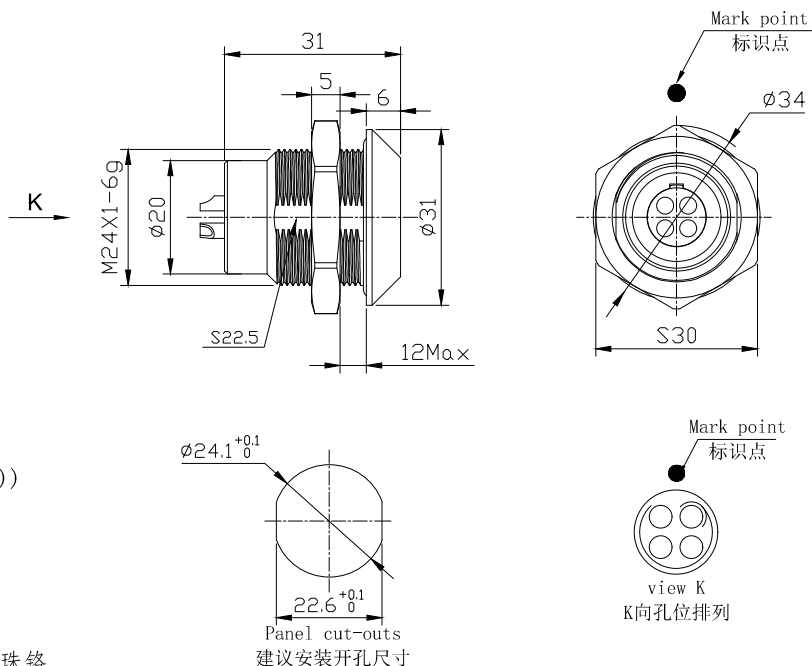

A

B

C

D

A

B

C

D

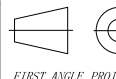
DRAWN BY: 绘图: P003 2024. 05. 28		 美易连电子科技(深圳)有限公司 Meiyilian electronic technology (shenzhen) Co., Ltd.
CHECKED BY: 审核: Z01 2024. 05. 28		
APPROVED BY: 核准: P005 2024. 05. 28		
GENERAL TOLERANCE (UNLESS SPECIFIED) ≤10 ±0.1 <10° ≤20 ±0.15 <20° ≤50 ±0.3 Angle ±1°		单位 UNIT: mm 名称 PART NAME MGG-3K固定式插座 MGG-3K Fixed socket
 FIRST ANGLE PROJECTION		比例 SCALE: 1: 1 型号 PART NAME MGG. 3K. 304. CLL
REV/版本	A1	SHEET: 1 OF 1