

1) Product main performance/产品主要性能指标:

Operating Temperature/工作温度: $-55^{\circ}\text{C}\sim 200^{\circ}\text{C}$
 Humidity(max)/最大潮湿: $\leq 95\%$ [at 60 deg C / 140 F]
 Shielding /屏蔽性能: 75dB(10MHz) 40dB(1GHz)
 Salt Spray Corrosion/盐雾: 96hr
 P op (max)/最大环境压力: 60 bar (870 psi)

Mechanical data/机械特性:

Vibration/振动: 15g[10Hz~2000Hz]
 Shock Resistance/冲击: 100g[6ms]
 Endurance (Shell)/机械寿命: 5000次
 Cable/配接电缆: $\phi 2.1\text{mm}-\phi 3.0\text{mm}$

2. 电气性能

Insert Configuration/针芯配置: 0T. 304 4Low Voltage
 Pin Size/接触件直径: $\phi 0.7\text{mm}$
 Contact resistance接触电阻: $\leq 12.5\text{m}\Omega$
 Insulation resistance/绝缘电阻: 5000M Ω (测试电压500V(DC))
 Withstand voltage/耐电压: 750V(AC)
 Rated working current额定工作电流: 7.0A

Other Specification/其它规格:

Contact PIN/接触体: Gold plated Tin bronze/锡青铜镀金
 Housing Material/外壳材质: Chrome plated brass/铜镀珍珠铬
 Other metal spare parts/其余金属件: Nickel plated brass/铜镀镍
 Insulator material/绝缘材料: PPS
 IP Rating/防护等级: IP68(插合状态)

*ALL MATERIALS ARE RoHS COMPLIANT/所有材料均符合RoHS要求.

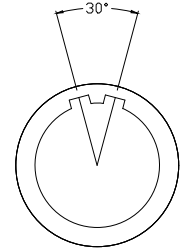
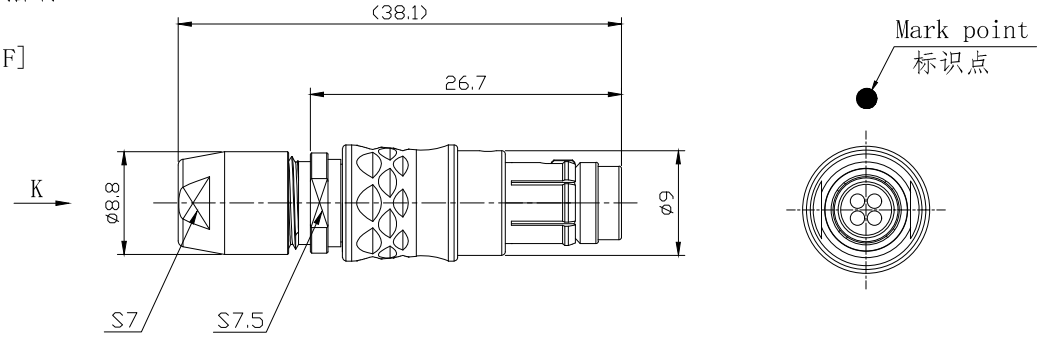

Plug front view
插头前视图

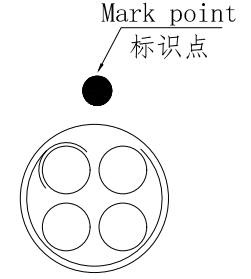

view K
K向孔位排列

DRAWN BY: 绘图: Z01 2024. 6. 20 CHECKED BY: 审核: Z01 2024. 6. 20 APPROVED BY: 核准: PD05 2024. 6. 20		 美易连电子科技(深圳)有限公司 Meiyilian electronic technology(shenzhen)Co. Ltd.	
GENERAL TOLERANCE (UNLESS SPECIFIED) $\leq 10 \pm 0.1$ $< 10^{\circ} \leq 20 \pm 0.15$ $< 20^{\circ} \leq 50 \pm 0.3$ Angle $\pm 1^{\circ}$		单位 UNIT: mm 比例 SCALE: 1: 1 名称 PART NAME 0T-TG直式插头 0T-TG Straight plug	型号 PART NAME TGA. 0T. 304. CLAC32
FIRST ANGLE PROJECTION	REV/版本 A1	SIZE: A4 SHEET: 1 OF 1	