

1) Product main performance/产品主要性能指标:

Operating Temperature/工作温度 : -55°C~200°C

Humidity(max)/最大潮湿 : <=95% [at 60 deg C / 140 F]

Shielding /屏蔽性能 : 75dB(10MHz) 40dB(1GHz)

Salt Spray Corrosion/盐雾 : 96hr

P op (max)/最大环境压力 : 60 bar (870 psi)

Mechanical data/机械特性:

Vibration/振动 : 15g[10Hz~2000Hz]

Shock Resistance/冲击 : 100g[6ms]

Endurance (Shell)/机械寿命 : 5000次

Cable/配接电缆:  $\phi 5.1\text{mm}-\phi 6.0\text{mm}$

2. 电气性能

Insert Configuration/针芯配置: 1T. 303 3Low Voltage

Pin Size/接触件直径:  $\phi 1.3\text{mm}$

Contact resistance接触电阻:  $\leq 5\text{m}\Omega$

Insulation resistance/绝缘电阻:  $5000\text{M}\Omega$  (测试电压500V (DC))

Withstand voltage/耐电压:  $1000\text{V}$  (AC)

Rated working current额定工作电流:  $12.0\text{A}$

Other Specification/其它规格:

Contact PIN/接触体: Gold plated Tin bronze/锡青铜镀金

Housing Material/外壳材质: Chrome plated brass/铜镀珍珠铬

Other metal spare parts/其余金属件: Nickel plated brass/铜镀镍

Insulator material/绝缘材料: PPS

IP Rating/防护等级: IP68(插合状态)

\*ALL MATERIALS ARE RoHS COMPLIANT/所有材料均符合RoHS要求.

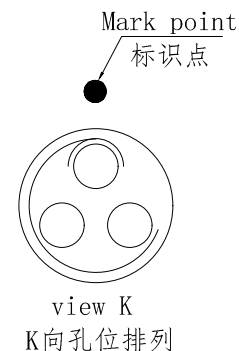
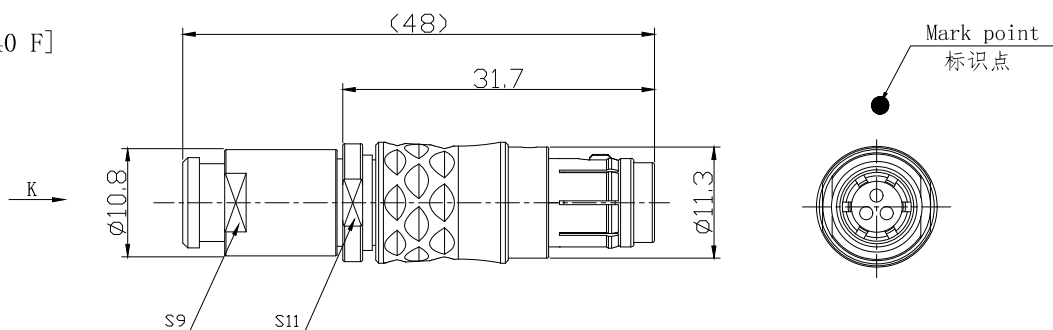

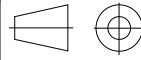
DRAWN BY: 绘图: Z01 2024. 6. 20 CHECKED BY: 审核: Z01 2024. 6. 20 APPROVED BY: 核准: P005 2024. 6. 20		 美易连电子科技(深圳)有限公司 Meiyilian electronic technology (shenzhen) Co. Ltd.	
GENERAL TOLERANCE (UNLESS SPECIFIED) $\leq 10 \pm 0.1$ $< 10^\circ \leq 20 \pm 0.15$ $< 20^\circ \leq 50 \pm 0.3$ Angle $\pm 1^\circ$	 FIRST ANGLE PROJECTION	单位 UNIT: mm	名称 PART NAME
		比例 SCALE: 1: 1	1T-TG直式插头 1T-TG Straight plug
REV/版本 A1	SHEET: 1 OF 1	型号 PART NAME	TGG. 1T. 303. CLAC62Z