

1) Product main performance/产品主要性能指标:

Operating Temperature/工作温度 : -55°C~200°C
 Humidity(max)/最大潮湿 : <=95% [at 60 deg C / 140 F]
 Shielding /屏蔽性能 : 75dB(10MHz) 40dB(1GHz)
 Salt Spray Corrosion/盐雾 : 96hr
 P op (max)/最大环境压力 : 60 bar (870 psi)

Mechanical data/机械特性:

Vibration/振动 : 15g[10Hz~2000Hz]
 Shock Resistance/冲击 : 100g[6ms]
 Endurance (Shell)/机械寿命 : 5000次
 Cable/配接电缆: $\phi 2.4\text{mm}-\phi 3.3\text{mm}$

2. 电气性能

Insert Configuration/针芯配置: 1T. 303 3Low Voltage
 Pin Size/接触件直径: $\phi 1.3\text{mm}$
 Contact resistance接触电阻: $\leq 5\text{m}\Omega$
 Insulation resistance/绝缘电阻: $5000\text{M}\Omega$ (测试电压500V(DC))
 Withstand voltage/耐电压: 1000V(AC)
 Rated working current额定工作电流: 12.0A

Other Specification/其它规格:

Contact PIN/接触体: Gold plated Tin bronze/锡青铜镀金
 Housing Material/外壳材质: Chrome plated brass/铜镀珍珠铬
 Other metal spare parts/其余金属件: Nickel plated brass/铜镀镍
 Insulator material/绝缘材料: PPS
 IP Rating/防护等级: IP68(插入状态)

*ALL MATERIALS ARE RoHS COMPLIANT/所有材料均符合RoHS要求.

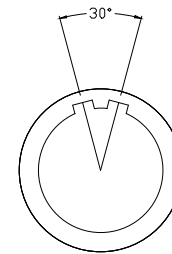
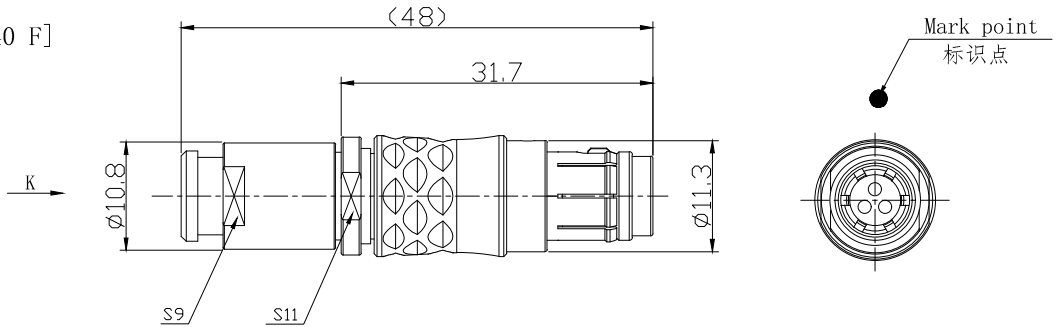

Plug front view
插头前视图

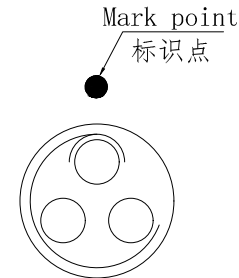

view K
K向孔位排列

DRAWN BY:
绘图: Z01 2024. 6. 20
CHECKED BY:
审核: Z01 2024. 6. 20
APPROVED BY:
核准: PD05 2024. 6. 20



美易连电子科技(深圳)有限公司
Meiyilian electronic technology (shenzhen) Co. Ltd.

GENERAL TOLERANCE
(UNLESS SPECIFIED)

$\leq 10 \pm 0.1$
 $< 10^\circ \leq 20 \pm 0.15$
 $< 20^\circ \leq 50 \pm 0.3$
 Angle $\pm 1^\circ$

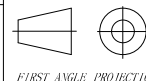

FIRST ANGLE PROJECTION

REV/版本 A1

单位
UNIT: mm
比例
SCALE: 1: 1

SIZE: A4

SHEET: 1 OF 1

名称
PART NAME

型号
PART NAME

1T-TG直式插头
1T-TG Straight plug

TGA. 1T. 303. CLAC35Z