

1) Product main performance/产品主要性能指标:

Operating Temperature/工作温度 : -55℃~200℃
 Humidity(max)/最大潮湿 : <=95% [at 60 deg C / 140 F]
 Shielding /屏蔽性能 : 75dB(10MHz) 40dB(1GHz)
 Salt Spray Corrosion/盐雾 : 96hr
 P op (max)/最大环境压力 : 60 bar (870 psi)

Mechanical data/机械特性:

Vibration/振动 : 15g[10Hz~2000Hz]
 Shock Resistance/冲击 : 100g[6ms]
 Endurance (Shell)/机械寿命 : 5000次
 Cable/配接电缆: $\phi 3.4\text{mm}-\phi 4.3\text{mm}$

2. 电气性能

Insert Configuration/针芯配置: 2T. 304 4Low Voltage
 Pin Size/接触件直径: $\phi 1.3\text{mm}$
 Contact resistance接触电阻: $\leq 5\text{m}\Omega$
 Insulation resistance/绝缘电阻: $5000\text{M}\Omega$ (测试电压500V(DC))
 Withstand voltage/耐电压: 1850V(AC)
 Rated working current额定工作电流: 15.0A

Other Specification/其它规格:

Contact PIN/接触体: Gold plated Tin bronze/锡青铜镀金
 Housing Material/外壳材质: Chrome plated brass/铜镀珍珠铬
 Other metal spare parts/其余金属件: Nickel plated brass/铜镀镍
 Insulator material/绝缘材料: PPS
 IP Rating/防护等级: IP68(插合状态)

*ALL MATERIALS ARE RoHS COMPLIANT/所有材料均符合RoHS要求.

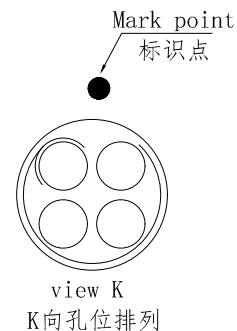
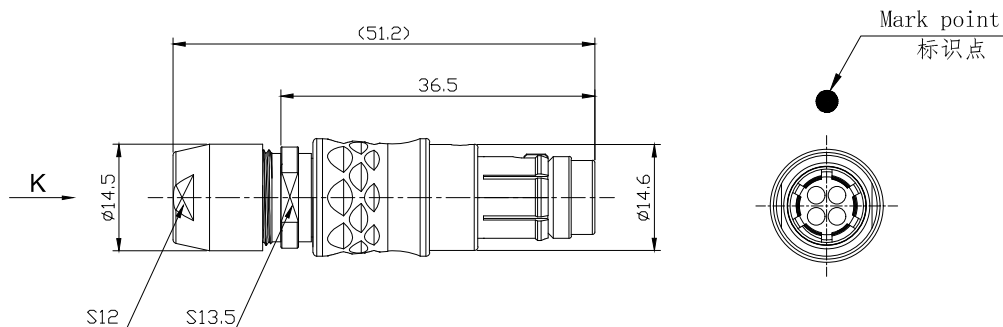

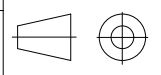
DRAWN BY: 绘图: Z01 2024. 6. 20 CHECKED BY: 审核: Z01 2024. 6. 20 APPROVED BY: 核准: PDO5 2024. 6. 20		 美易连电子科技(深圳)有限公司 Meiyilian electronic technology(shenzhen)Co.Ltd.	
GENERAL TOLERANCE (UNLESS SPECIFIED) ≤ 10 ± 0.1 $< 10 \sim \leq 20$ ± 0.15 $< 20 \sim \leq 50$ ± 0.3 Angle $\pm 1^\circ$		 FIRST ANGLE PROJECTION	单位 UNTT: mm 名称 PART NAME 2T-TG直式插头 2T-TG Straight plug
REV/版本 A1		比例 SCALE: 1: 1 型号 PART NAME TGG. 2T. 304. CLAC45	SIZE: A4 SHEET: 1 OF 1