

1) Product main performance/产品主要性能指标:

Operating Temperature/工作温度: -55°C~200°C
 Humidity(max)/最大潮湿: <=95% [at 60 deg C / 140 F]
 Shielding /屏蔽性能: 75dB(10MHz) 40dB(1GHz)
 Salt Spray Corrosion/盐雾: 96hr
 P op (max)/最大环境压力: 60 bar (870 psi)

Mechanical data/机械特性:

Vibration/振动: 15g[10Hz~2000Hz]
 Shock Resistance/冲击: 100g[6ms]
 Endurance (Shell)/机械寿命: 5000次
 Cable/配接电缆: $\phi 10.1\text{mm}-\phi 11.0\text{mm}$

2. 电气性能

Insert Configuration/针芯配置: 3T. 316 16Low Voltage
 Pin Size/接触件直径: $\phi 0.9\text{mm}$
 Contact resistance接触电阻: $\leq 9\text{m}\Omega$
 Insulation resistance/绝缘电阻: $5000\text{M}\Omega$ (测试电压500V(DC))
 Withstand voltage/耐电压: 850V(AC)
 Rated working current额定工作电流: 8.0A

Other Specification/其它规格:

Contact PIN/接触体: Gold plated Tin bronze/锡青铜镀金
 Housing Material/外壳材质: Chrome plated brass/铜镀珍珠铬
 Other metal spare parts/其余金属件: Nickel plated brass/铜镀镍
 Insulator material/绝缘材料: PPS
 IP Rating/防护等级: IP68(头座插合)

*ALL MATERIALS ARE RoHS COMPLIANT/所有材料均符合RoHS要求.

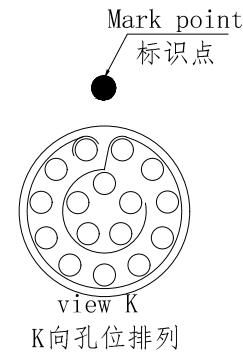
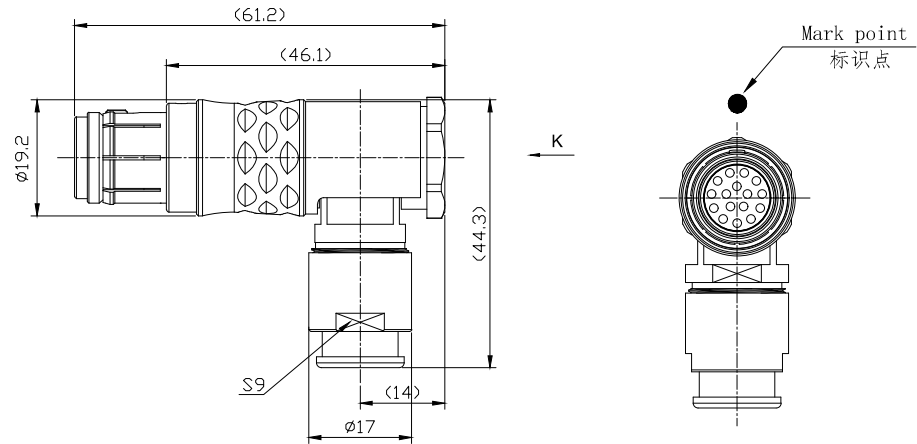

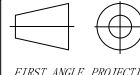
DRAWN BY: 绘图: Z01 2024. 6. 20 CHECKED BY: 审核: Z01 2024. 6. 20 APPROVED BY: 核准: PD05 2024. 6. 20	 美易连电子科技(深圳)有限公司 Meiyilian electronic technology (shenzhen) Co. Ltd.		
GENERAL TOLERANCE (UNLESS SPECIFIED) $\leq 10 \pm 0.1$ $< 10^\circ \leq 20 \pm 0.15$ $< 20^\circ \leq 50 \pm 0.3$ Angle $\pm 1^\circ$	 FIRST ANGLE PROJECTION	单位 UNIT: mm	名称 PART NAME
		比例 SCALE: 1: 1	3T-TH直式插头(带护套式尾帽) 3T-TH Straight plug (with jacketed tail cap)
REV/版本	A1	型号 PART NAME	THG. 3T. 316. CLAC120Z
		SIZE: A4	SHEET: 1 OF 1